

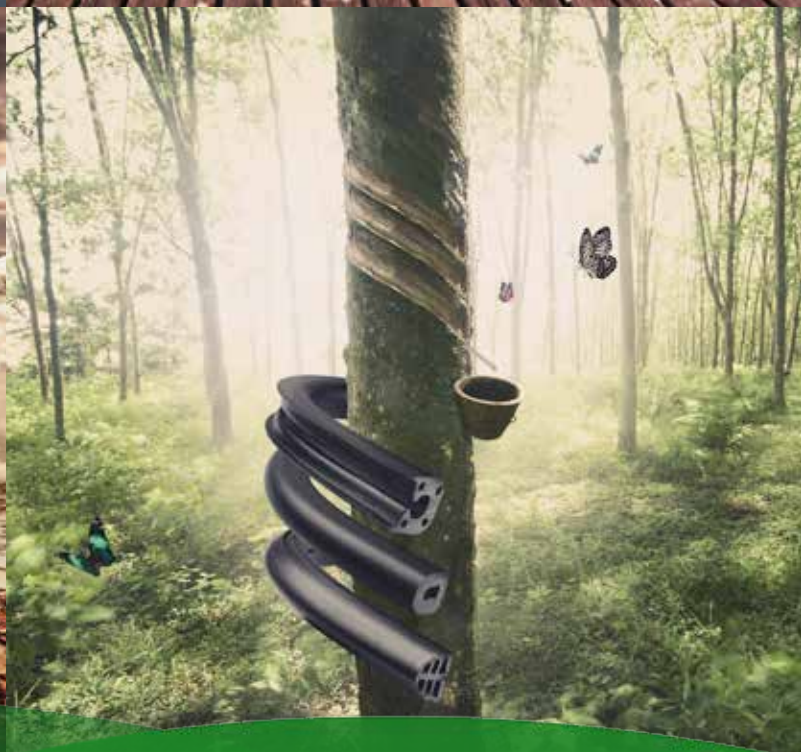

RUBBER

H O L L A N D

2024
2025





BATTERY CABLE

BATTERIEKABEL

ACCUKABELS

ELECTRICITY

ELEKTRO

ELECTRA

PVC AND RUBBER PRODUCTS

PVC- UND GUMMIPRODUKTE

PVC- EN RUBBERPRODUCTEN

HOSES

SCHLÄUCHE

SLANGEN

HOSE CLAMPS

SCHLAUCHSCHELLEN

KLEMMEN

FITTINGS

FITTINGE

FITWERK

HEP20

HEP20

HEP20 SYSTEEM

LOOPVLAKSTRUCTUREN

TERMS AND CONDITIONS

ALGEMENE (LEVERINGS)VOORWAARDEN







**ACCUKABELS
BATTERY CABLES
BATTERIEKABEL**

FLEXIBELE ACCUKABEL

- OLIBESTENDIG - OIL RESISTANT - ÖLBESTÄNDIG
- ZEER FLEXIBEL - CLASS 6 VERY FLEXIBLE - KLASSE 6 KABEL

VOOR DATASHEET KIJK OP ONZE WEBSITE

LOOK FOR DATASHEET ON OUR WEBSITE

DATENBLATT AUF UNSERER WEBSITE



DUBBELGEÏSOLEERDE ACCUKABEL ROOD **DOUBLE ISOLATED BATTERY CABLE RED** **DOPPEL ISOLIERTE BATTERIEKABEL ROT**

nr.	mm ²	∅	haspel / reel / Rolle
3399910/r	10	8,6	50
3399916/r	16	9	50
3399925/r	25	10	50
3399935/r	35	12	50
3399950/r	50	14,3	50
3399970/r	70	16	50
3399995/r	95	18/19	50
3399120/r	120	21	50
drum			
3399910/r500	10	8,6	500
3399916/r500	16	9	500
3399925/r500	25	10	500
3399935/r500	35	12	500
3399950/r500	50	14,3	500
3399970/r500	70	16	500
3399995/r500	95	18/19	500
3399120/r500	120	21	500

DUBBELGEÏSOLEERDE ACCUKABEL ZWART **DOUBLE ISOLATED BATTERY CABLE BLACK** **DOPPEL ISOLIERTE BATTERIEKABEL SCHWARZ**

nr.	mm ²	∅	haspel / reel / Rolle
3399910/z	10	8,6	50
3399916/z	16	9	50
3399925/z	25	10	50
3399935/z	35	12	50
3399950/z	50	14,3	50
3399970/z	70	16	50
3399995/z	95	18/19	50
3399120/z	120	21	50
drum			
3399910/z500	10	8,6	500
3399916/z500	16	9	500
3399925/z500	25	10	500
3399935/z500	35	12	500
3399950/z500	50	14,3	500
3399970/z500	70	16	500
3399995/z500	95	18/19	500
3399120/z500	120	21	500

DUBBELGEÏSOLEERDE ACCUKABEL ORANJE **DOUBLE ISOLATED BATTERY CABLE ORANGE** **DOPPEL ISOLIERTE BATTERIEKABEL ORANGE**

nr.	mm ²	∅	haspel / reel / Rolle
3399910/o	10	8,6	50
3399916/o	16	9	50
3399925/o	25	10	50
3399935/o	35	12	50
3399950/o	50	14,3	50
3399970/o	70	16	50
3399995/o	95	18/19	50

Op aanvraag leverbaar / on request / auf Anfrage: 500 meter





DUBBELGEÏSOLEERDE ACCUKABEL **DOUBLE ISOLATED BATTERY CABLE** **DOPPEL ISOLIERTE BATTERIEKABEL**

IEC 60332-3

nr.	mm ²	∅	haspel / reel / Rolle
9530016/r	16	9,3	50
9530016/z	16		50
9530025/r	25	10	50
9530025/z	25		50
9530035/r	35	11,4	50
9530035/z	35		50
9530050/r	50	13,8	50
9530050/z	50		50
9530070/r	70	16	50
9530070/z	70		50
9530095/r	95	18	50
9530095/z	95		50
9530120/r	120	22	50
9530120/z	120		50

 Indien kabels gebundeld of door een bedradingskoker gelegd worden dienen kabels aan de strengere eis van de IEC 60332-3 te voldoen.

 When cables are bundled or put trough a cable tray the cable has to perform according to the requirments of the IEC 60332-3.

 Wenn Kabel gebündelt oder durch einen Verdrahtungskanal verlegt werden, müssen Kabel die strengeren Anforderungen der IEC 60332-3 erfüllen.



KABELSNIJDER **CABLE CUTTER** **KABELSCHNEIDER**

nr.	∅
3459090	SFK 45 Elec Max 45mm



HALOGEENVRIJE VERTINDE KABELS **HALOGEN FREE TINNED CABLE** **HALOGENFREIES VERZINNTES KABEL**

90 °C LLOYDS

nr.	mm ²	∅	haspel / reel / Rolle
3377716/r	16	8	50
3377716/z	16	8	50
3377725/r	25	9	50
3377725/z	25	9	50
3377735/r	35	9/10	50
3377735/z	35	9/10	50
3377750/r	50	11	50
3377750/z	50	11	50
3377770/r	70	13,5	50
3377770/z	70	13,5	50
3377795/r	95	17	50
3377795/z	95	17	50
3377120/r	120	19	50
3377120/z	120	19	50



KABELSCHOENEN **POWERLUGS** **KABELSCHUHE**

BLADZIJDE / PAGE / SEITE 24- 26

DUNWANDIGE LAAG SPANNINGS BEDRADINGSKABEL
THINWALL CABLE: ONLY DC
EINADRIGE ANSCHLUSS-UND STEURKABEL NUR DC

- ISO 6722-1:2011 (CLASS B) 105° C
- 12V / 24V SYSTEMEN (MAX 60V)
- -40° C TOT 105°C
- OLIEBESTENDIG - OIL RESISTANT - ÖLBESTÄNDIG

nr.	mm ²	Ø	haspel / reel / Rolle
340501/100	0,5	●	1,5 100
340502/100	0,5	●	100
340507/100	0,5	●	100
340505/100	0,5	●	100
340506/100	0,5	●	100
340503/100	0,5	●	100
340508/100	0,5	●	100
340509/100	0,5	●	100
340510/100	0,5	●	100
340511/100	0,5	○	100
340512/100	0,5	●	100
340504/100	0,5	●	100
340751/100	0,75	●	1,7 100
340752/100	0,75	●	100
340757/100	0,75	●	100
340755/100	0,75	●	100
340756/100	0,75	●	100
340753/100	0,75	●	100
340758/100	0,75	●	100
340759/100	0,75	●	100
3407510/100	0,75	●	100
3407511/100	0,75	○	100
3407512/100	0,75	●	100
340754/100	0,75	●	100
341001/100	1	●	2,0 100
341002/100	1	●	100
341007/100	1	●	2,1 100
341005/100	1	●	100
341006/100	1	●	100
341003/100	1	●	100
341008/100	1	●	100
341009/100	1	●	100
341010/100	1	●	100
341011/100	1	○	100
341012/100	1	●	100
341004/100	1	●	100

nr.	mm ²	Ø	haspel / reel / Rolle
341501/100	1,5	●	2,4 100
341502/100	1,5	●	100
341507/100	1,5	●	100
341505/100	1,5	●	100
341506/100	1,5	●	100
341503/100	1,5	●	100
341508/100	1,5	●	100
341509/100	1,5	●	100
341510/100	1,5	●	100
341511/100	1,5	○	100
341512/100	1,5	●	100
341504/100	1,5	●	100
342001/100	2	●	2,7 100
342002/100	2	●	100
342006/100	2	●	100
342004/100	2	●	100
342005/100	2	●	100
342003/100	2	●	100
342007/100	2	●	100
342008/100	2	●	100
342009/100	2	●	100
342010/100	2	○	100
342011/100	2	●	100
342501/100	2,5	●	3,2 100
342502/100	2,5	●	100
342511/100	2,5	●	100
342503/100	2,5	●	100
342504/100	2,5	●	100
342505/100	2,5	●	100
342506/100	2,5	●	100
342507/100	2,5	○	100
342508/100	2,5	●	100
3440001/100	4	●	3,5 100
3440002/100	4	●	100
3440003/100	4	●	100
3440004/100	4	●	100
3440005/100	4	●	100
346001/100	6	●	4,4 100
346003/100	6	●	100
346004/100	6	●	100
346002/100	6	●	100
346005/100	6	●	100
346010/100	6	●	100
349001/100	10	●	6,0 100
349003/100	10	●	100
349002/100	10	●	100



DUNWANDIGE LAAG SPANNINGS BEDRADINGSKABEL
THINWALL CABLE: ONLY DC
EINADRIGE ANSCHLUSS-UND STEURKABEL NUR DC

- TWEEKLEURIGE KABEL / TWOCOLORED CABLE / ZWEIFARBIGE KABEL
- ISO 6722-1:2011 (CLASS B) 105° C
- 12V / 24V SYSTEMEN (MAX 60V)
- -40° C > 105°C
- OLIEBESTENDIG - OIL RESISTANT - ÖLBESTÄNDIG

nr.	mm ²	Ø	haspel / reel / Rolle
340513/100	0,5	●	1,5 100
340514/100	0,5	●	100
340515/100	0,5	●	100
340516/100	0,5	●	100
340517/100	0,5	●	100
340518/100	0,5	●	100
340519/100	0,5	●	100
340520/100	0,5	●	100
340521/100	0,5	●	100
340522/100	0,5	●	100
340523/100	0,5	●	100
340524/100	0,5	●	100
340525/100	0,5	●	100
340526/100	0,5	●	100
340527/100	0,5	●	100
340528/100	0,5	○	100
340529/100	0,5	○	100
340530/100	0,5	○	100
340531/100	0,5	●	100
340532/100	0,5	●	100
340533/100	0,5	●	100
340534/100	0,5	○	100
340535/100	0,5	●	100
340536/100	0,5	●	100
340537/100	0,5	●	100
340538/100	0,5	●	100
340539/100	0,5	●	100
340540/100	0,5	●	100
340541/100	0,5	●	100
340542/100	0,5	●	100
340543/100	0,5	●	100
340544/100	0,5	●	100
340545/100	0,5	●	100
340546/100	0,5	●	100
3407513/100	0,75	●	1,7 100
3407514/100	0,75	●	100
3407515/100	0,75	●	100
3407516/100	0,75	●	100
3407517/100	0,75	●	100
3407518/100	0,75	●	100
3407519/100	0,75	●	100
3407520/100	0,75	●	100
3407521/100	0,75	●	100
3407522/100	0,75	●	100
3407523/100	0,75	●	100
3407524/100	0,75	●	100
3407525/100	0,75	○	100

340760/100	0,75	●	100
340761/100	0,75	●	100
340762/100	0,75	●	100
340763/100	0,75	●	100
340764/100	0,75	●	100
340765/100	0,75	●	100
341013/100	1	●	2,0 100
341014/100	1	●	100
341015/100	1	●	100
341016/100	1	●	100
341017/100	1	●	100
341018/100	1	●	100
341019/100	1	●	100
341020/100	1	●	100
341021/100	1	●	100
341022/100	1	●	100
341023/100	1	●	100
341024/100	1	●	100
341025/100	1	●	100
341026/100	1	●	100
341027/100	1	●	100
341028/100	1	●	100
341029/100	1	●	100
341030/100	1	●	100
341031/100	1	●	100
341032/100	1	●	100
341033/100	1	●	100
341036/100	1	●	100
341037/100	1	●	100
341038/100	1	●	100
341039/100	1	●	100
341040/100	1	●	100
341041/100	1	●	100
341042/100	1	●	100
341043/100	1	●	100
341044/100	1	●	100
341045/100	1	●	100
341046/100	1	●	100
341047/100	1	●	100
341048/100	1	●	100
341049/100	1	●	100
341050/100	1	●	100
341051/100	1	●	100
341053/100	1	●	100
341055/100	1	●	100
341056/100	1	●	100
341058/100	1	●	100
341059/100	1	●	100



341060/100	1		100	341105/500	1		500	
341061/100	1		100	341107/500	1		500	
341062/100	1		100	341513/100	1,5		2,4	100
341063/100	1		100	341514/100	1,5		100	
341064/100	1		100	341515/100	1,5		100	
341065/100	1		100	341516/100	1,5		100	
341066/100	1		100	341517/100	1,5		100	
341067/100	1		100	341518/100	1,5		100	
341068/100	1		100	341519/100	1,5		100	
341069/100	1		100	341520/100	1,5		100	
341070/100	1		100	341521/100	1,5		100	
341071/100	1		100	341522/100	1,5		100	
341072/100	1		100	341523/100	1,5		100	
341073/100	1		100	341524/100	1,5		100	
341074/100	1		100	341525/100	1,5		100	
341076/100	1		100	341533/100	1,5		100	
341077/100	1		100	341534/100	1,5		100	
341078/100	1		100	341536/100	1,5		100	
341079/100	1		100	341537/100	1,5		100	
341080/100	1		100	341538/100	1,5		100	
341081/100	1		100	341539/100	1,5		100	
341082/100	1		100	341540/100	1,5		100	
341083/100	1		100	341541/100	1,5		100	
341084/100	1		100	341542/100	1,5		100	
341085/100	1		100	341543/100	1,5		100	
341086/100	1		100	341544/100	1,5		100	
341087/100	1		100	341545/100	1,5		100	
341088/100	1		100	341546/100	1,5		100	
341089/100	1		100	341519/500	1,5		500	
341090/100	1		100	341520/500	1,5		500	
341091/100	1		100	341533/500	1,5		500	
341092/100	1		100	341534/500	1,5		500	
341093/100	1		100	341535/500	1,5		500	
341094/100	1		100	341536/500	1,5		500	
341095/100	1		100	342012/100	2		2,7	100
341096/100	1		100	342013/100	2		100	
341097/100	1		100	342014/100	2		100	
341098/100	1		100	342015/100	2		100	
341099/100	1		100	342016/100	2		100	
341100/100	1		100	342017/100	2		100	
341101/100	1		100	342018/100	2		100	
341102/100	1		100	342019/100	2		100	
341103/100	1		100	342020/100	2		100	
341104/100	1		100	342021/100	2		100	
341105/100	1		100	342022/100	2		100	
341106/100	1		100	342023/100	2		100	
341107/100	1		100	342024/100	2		100	
341021/500	1		500	342025/100	2		100	
341026/500	1		500	342026/100	2		100	
341035/500	1		500	342027/100	2		100	
341036/500	1		500	342028/100	2		100	
341037/500	1		500	342029/100	2		100	
341066/500	1		500	342030/100	2		100	
341067/500	1		500	342031/100	2		100	
341071/500	1		500	342032/100	2		100	
341072/500	1		500	342034/100	2		100	
341073/500	1		500	342035/100	2		100	
341074/500	1		500	342036/100	2		100	
341075/500	1		500	342037/100	2		100	
341078/500	1		500	342038/100	2		100	
341083/500	1		500					
341097/500	1		500					

342039/100	2		100
342040/100	2		100
342041/100	2		100
342042/100	2		100
342043/100	2		100



**MONTAGESNOER H07V2-K
UNIPOLAR CABLE
EINADRIGE ANSCHLUSS UND STEUER
LEITUNG**

90°C - 450AC-750DC

nr.	mm ²	Ø	haspel / reel / Rolle
33699150	1,5		3 100
33699151	1,5		100
33699152	1,5		100
33699153	1,5		100
33699154	1,5		100
33699155	1,5		100
33699156	1,5		100
33699157	1,5		100
33699158	1,5		100
33699159	1,5		100

33699250	2,5		3,6 100
33699251	2,5		100
33699252	2,5		100
33699253	2,5		100
33699254	2,5		100
33699255	2,5		100
33699256	2,5		100
33699257	2,5		100

33699400	4		4 100
33699401	4		100
33699402	4		100
33699403	4		100
33699404	4		100
33699405	4		100

33699600	6		5 100
33699601	6		100
33699100	10		7 100
33699101	10		100



**HALOGEENVRIJE VERTINDE KABELS
HALOGENFREE TINNED CABLE
HALOGENFREIES VERZINNTES KABEL**

90°C LLOYDS

nr.	mm ²	Ø	haspel / reel / Rolle
33777050/r	0,50		2 100
33777050/z	0,50		100
33777075/r	0,75		2,3 100
33777075/z	0,75		100
33777001/r	1,00		2,7 100
33777001/z	1,00		100
33777150/r	1,50		3,1 100
33777150/z	1,50		100
33777150/gg	1,50		100
33888250/r	2,50		3,7 100
33888250/z	2,50		100
33777250/r	2,50		3,7 100
33777250/z	2,50		100
33777400/r	4,00		3,8 100
33777400/z	4,00		100
33777600/r	6,00		4,3 100
33777600/z	6,00		100
33777100/r	10		6,0 100
33777100/z	10		100



**COAX KABEL COAX CABLE
KOAXIALKABEL**

nr.	soort	haspel / reel / Rolle
30-21700005	50 OHM RG 213	50
3366650	50 OHM (marifoon) RG58	5,0mm 100
3366125	75 OHM H125 catv	7,0mm 100
3366675	75 OHM (tv-kabel) RG59	6,1mm 100
90-99990030	50 OHM Aircell 7	7,1mm 100



**SOLAR KABEL SOLAR CABLE
SOLARKABEL**

nr.	kleur	mm ²	Ø	haspel / reel / Rolle
33123414		4	5,1	100/500
33123404		4		100/500
33123616		6	6,5	100/500
33123606		6		100/500



PVC KABEL H05VV-F GEEL
TRIPOLAR POWER CABLE YELLOW
PVC STROMKABEL GELB, FÜR AC 230V

300/500 volt.

nr.		mm ²	∅	haspel / reel / Rolle
3367315		3 x 1,5	8,2	100
3367315/500		3 x 1,5		500
3367325		3 x 2,5	10,2	75
3367325/500		3 x 2,5		500
3367304		3 x 4		50
3367306		3 x 6	12,1	50
3367525		5 x 2,5		50



GRIJZE PVC KABEL H05VV-F
TRIPOLAR POWER CABLE GREY
PVC STROMKABEL GRAU, FÜR AC 230V

300/500 volt

nr.		mm ²	∅	haspel / reel / Rolle
336782075		2 x 0,75		100
336782075/500		2 x 0,75		500
33678215		2 x 1,5	7,8	100
33678215/500		2 x 1,5		500
33678225		2 x 2,5	9,1	100
33678225/500		2 x 2,5		500
33678315		3 x 1,5	8,4	100
33678415		4 x 1,5		100
33678515		5 x 1,5	10	50
33678204		2 x 4	10,5	50
33678206		2 x 6		50
33678715		7 x 1,5		100



PVC KABEL H05VV-F GEEL
TRIPOLAR POWER CABLE YELLOW
PVC STROMKABEL GELB, FÜR AC 230V

IEC 60332-1-2 / IEC 60332-3-24

300/500 volt.

nr.		mm ²	haspel / reel / Rolle
95367315		3 x 1,5	100
95367325		3 x 2,5	75

Indien kabels gebundeld of door een bedradingskoker gelegd worden dienen kabels aan de strengere eis van de IEC 60332-3 te voldoen.

When cables are bundled or put trough a cable tray the cable has to perform according to the requirements of the IEC 60332-3.

Wenn Kabel gebündelt oder durch einen Verdrahtungskanal verlegt werden, müssen Kabel die strengeren Anforderungen der IEC 60332-3 erfüllen.



H07RN-F NEOPREENKABEL
NEOPRENE CABLE
NEOPREN-KABEL

ZEER SOEPEL / VERY FLEXIBLE / EXTREM FLEXIBEL

nr.		mm ²	∅	haspel / reel / Rolle
3366215		2 x 1,5	8,2	50
3366315		3 x 1,5	9,5	50
3366415		4 x 1,5	9,5	50
3366515		5 x 1,5	11,6	50
3366225		2 x 2,5	10,1	50
3366325		3 x 2,5		50
3366425		4 x 2,5	9,5	50
3366525		5 x 2,5		50
3366560		5 x 6,0	18,3	50
3366204		2 x 4	12	50
3366304		3 x 4	12,9	50
3366404		4 x 4		50
3366306		3 x 6	13,0	50
3366310		3 x 10		50



ZWARTE AUTOKABEL H05VV-F
TRIPOLAR POWER CABLE BLACK
STROMKABEL SCHWARZ, FÜR AC 230V

nr.		mm ²	∅	haspel / reel / Rolle
30-29450		2 x 0,75		100
30-29484		2 x 1,5		100
30-29485		2 x 2,5		100
30-29452		3 x 0,75		100
30-29468		3 x 1,5		100
30-29478		3 x 2,5		75
30-29525		5 x 2,5		50
30-29701	7 aderig:	7 x 1	7,9	50
30-29114	14 aderig:	9 x 1,5	13,9	50
		5 x 2,5		



HALOGEENVRIJ VERTINDE KABEL GEEL
HALOGEN FREE TINNED CABLE YELLOW
HALOGENFREIES VERZINNTES KABEL GELB

IEC 60332-1-2 / IEC 60332-3-24

300/500 volt.

nr.		mm ²	haspel / reel / Rolle
337770315		3 x 1,5	500
337770325		3 x 2,5	500
337770306		3 x 6,0	500
337770316		3 x 16	500



LUIDSPREKER KABEL **SPEAKER CABLE**
LAUTSPRECHERKABEL

nr		mm ²	∅	haspel / reel / Rolle
33662075	●●	2 x 0,75	2,3 - 4,7	100
3368215	●●	2 x 1,5	2,5 - 5,5	100
3368225	●●	2 x 2,5	3,3 - 6,9	100



PLATTE PVC KABEL **FLAT CABLE** **FLACHKABEL**

nr		mm ²	∅	haspel / reel / Rolle
33667075	●●	2 x 0,75	3,5 - 5,6	100
3366710	●●	2 x 1	4,5 - 7,0	100
3366715	●●	2 x 1,5	4,8 - 7,5	100
3366725	●●	2 x 2,5	5,2 - 8,4	100
33667075/500	●●	2 x 0,75	3,5 - 5,6	500
3366710/500	●●	2 x 1	4,5 - 7,0	500
3366715/500	●●	2 x 1,5	4,8 - 7,5	500
3366725/500	●●	2 x 2,5	5,2 - 8,4	500



RONDE VERTINDE KABEL
TINNED TRIPOLAR ROUND CABLE
VERZINNTES MEHRADRIGES RUNDKABEL

BLACK SHEATHED / AUSSENMANTEL SCHWARZ / ZWART OMHULD

nr		mm ²	∅	haspel / reel / Rolle
3388215	●●	2 x 1,5	7,1	100
3388315	●●●	3 x 1,5	8,3	100
3388415	●●○	4 x 1,5	9,0	100
3388415/500	●●○	4 x 1,5	9,0	500
3388225	●●	2 x 2,5		100
3388204	●●	2 x 4	10	100



TWINFLEX ACCUKABEL PVC ROOD/ZWART
BIPOLAR BATTERY CABLE RED/BLACK
ZWEIADRIGES BATTERIEKABEL ROT/SCHWARZ

nr	soort	mm ²	∅	haspel / reel / Rolle
3368804	twin	2 x 4	5,8 - 12,3	50
3368806	twin	2 x 6	6,0 - 12,5	50
3368810	twin	2 x 10	8,2 - 16,2	50
3368816	twin	2 x 16	8,4 - 18,2	50
3368825	twin	2 x 25	9,4 - 20,1	25
3368835	twin	2 x 35	10,9 - 25,7	25
3368850	twin	2 x 50	14,3 - 28	25
drum				
3368804/500	twin	2 x 4	5,8 - 12,3	500
3368806/500	twin	2 x 6	6,0 - 12,5	500
3368810/500	twin	2 x 10	8,2 - 16,2	500
3368816/500	twin	2 x 16	8,4 - 18,2	500

Op verzoek / on request / auf Anfrage 2 x 70mm² und 2 x 95 mm²



PU WALSTROOMKABEL HO5/7BQ-F GEEL
TRIPOLAR SHORE POWER CABLE HO5/7BQ-F YELLOW
LANDSTROM KABEL HO5/7BQ-F GELB

nr.	mm ²		∅	belastbaar tot / taxable upto/ strombelastbarkeit bis zu	haspel / reel / Rolle
33668315	3 x 1,5	●●●	9,4	10 A	50
33668325	3 x 2,5	●●●	11,2	16 A	50
33668304	3 x 4	●●●	13	25 A	50
33668306	3 x 6	●●●	14	32 A	50
33668310	3 x 10	●●●	18	40 A	50
33668316	3 x 16	●●●	21	50 A	50

STUURSTROOM KABELS
CONTROL CABLE
STEURLEITUNG UNGESCHIRMT

Nominale spanning: 300/500 volt

nr.		∅	mm ²	haspel / reel / Rolle
LIYY 215	● 1,2	6,0	1,5	100
LIYY 225	● 1,2	7,9	2,5	100
LIYY1215	● 1 > 11 + ●		1,5	50
LIYY3075	● 1,2 + ●	5	3 x 0,75	100
LIYY3075C	●●○	6,1	3 x 0,75	100
LIYY401	● 1 > 3 + ●	6,2	4 x 1	100
LIYY315	● 1,2 + ●	7	3 x 1,5	100
LIYY415	● 1 > 3 + ●		4 x 1,5	100
LIYY515	● 1 > 4 + ●	8,8	5 x 1,5	100
LIYY715	● 1 > 7	7,1	7 x 1,5	100
LIYY325	● 1,2 + ●	5,8	3 x 2,5 mm ²	100



STUURSTROOM KABELS AFGESCHERMD
CONTROL CABLE SHIELDED
STEURLEITUNG GESCHIRMT

nr.		∅	mm ²	haspel / reel / Rolle
LIICY2075	● 1,2	5,2	2 x 0,75	100
LIICY225	● 1,2	7,8	2 x 2,5	100
LIICY315	● 1,2 + ●	6,5	3 x 1,5	100
LIICY415	● 1 > 3 + ●	8,5	4 x 1,5	100
LIICY715	● 1 > 6 + ●	9,5	7 x 1,5	100



PU KABEL BEHOREND BIJ DE MP INLET
SHORE POWER CABLE AND PLUG WITH BUILT IN LEDLIGHT
LANDANSCHLUSSKABEL MIT MP STECKER MIT LEDLEUCHTE

1 uiteinde voorzien van een gele MP inlet stecker met led;
 andere uiteinde voorzien een CEE stecker voor de walaansluiting.

nr.	mm ²	max bel./maxable upto/ strombelastbarkeit bis zu	haspel / reel / Rolle
3556315	3 x 1,5	10A	15
3557325	3 x 1,5	10A	25
3552823	3 x 2,5	16A	5
3558315	3 x 2,5	16A	15
3559325	3 x 2,5	16A	25
3552836	3 x 4	25A	15
3552832	3 x 4	25A	25
3552837	3 x 6	32A	15
3552838	3 x 6	32A	25
3552851	3 x 10	50A	15
3552852	3 x 10	50A	25



COMPLEET AC SYSTEEM 16A BASISKIT **BASIC POWERSYSTEM**
KOMPLETTES LANDANSCHLUSS SYSTEM

1 x RVS inlet, 1 x walstroom kabel 3 x 1,5mm² 15 meter, 2-voudig stopcontact, aardlek in kast, verbindingkabel 1 x 1 meter en 1 x 2 meter.

Plug-and-play systeem

Bestelnummer: 35AC16B



COMPLEET AC SYSTEEM 16A
VOOR KLEINE BOTEN / FOR SMALL BOATS / FÜR KLEINE BOTE

nr.	omschrijving	lengte
35MP16P	1x kunststof verchromde inlet, aardlek in kast en 1x walstroom kabel 3 x 1,5mm ²	15 meter
35MP16P/25	1x kunststof verchromde inlet, aardlek in kast en 1x walstroom kabel 3 x 1,5mm ²	25 meter
35MP16P/RVS	1x RVS inlet, aardlek in kast en 1x walstroom kabel 3 x 1,5mm ²	15 meter
35MP16P/K	1x kunststof inlet, aardlek in kast en 1x walstroom kabel 3 x 1,5 mm ²	15 meter



ADAPTERSET

nr.	omschrijving	lengte
70022	Adapter cord set schuko to CEE	0,30 meter
70026	Adapter cord set CEE to schuko	0,30 meter
70024	Splitter CEE / twin socket	0,50 meter



MARINCO CONTRA CEE STEKKER
POWERCABLE FOR MARINCO SOCKETS
LANDANSCHLUSSKABEL FÜR MARINCO BORDSTECKDOSE

nr.	mm ²	haspel / reel / Rolle
3552812	3 x 2,5	25 meter
3552811	3 x 2,5	15 meter



CEE VERLENGSNOER
CEE EXTENSION CABLE
CEE VERLÄNGERUNGSKABEL

nr.	mm ²	haspel / reel / Rolle
3552835	3 x 2,5	25 meter





MP LOSSE STEKKERS
MP PLUGS
MP STECKER

nr.	omschrijving	maximale belasting
35588816	MP stekker / plug / stecker	16A
35588832	MP stekker / plug / stecker	32A
35588850	MP stekker / plug / stecker	50A

MP INLET COMPLEET
MP SOCKET COMPLETE
MP BORDSTECKDOSE KOMPLETT

nr.	omschrijving	maximale belasting
3556624	230V rvs/stainless steel/edelstahlgehäuse	16A
35599916/CH	230V chroom/chrome/chrom	16A
35599916	230V kunststof/plastic/kunststoff	16A
3553216	230V rvs/stainless steel/edelstahlgehäuse	32A
3555050	230V rvs/stainless steel/edelstahlgehäuse	50A



RVS INLET MET SNOER
SOCKET WITH CORD
BORDSTECKDOSE MIT KABEL
TBV 35AC EN 35 MP

nr.	Omschrijving	maximale belasting
355AC16-01	rvs/stainless steel edelstahlgehäuse	16A



MP WCD SCHUKO OUTLET MET RVS KLEP
SCHUKO OUTLET SOCKET STAINLESS STEEL
**EINBAU SCHUKO STECKDOSE MIT EDEL-
 STAHLGEHÄUSE**

nr.	Omschrijving	maximale belasting
3556625	WCD schuko outlet met RVS klep	16A
3556627	WCD schuko outlet met kunststof klep	16A



PVC INLET MET SNOER
SOCKET WITH CORD
BORDSTECKDOSE MIT KABEL
TBV 35AC EN 35 MP

nr.	Omschrijving	maximale belasting
355AC16-01K	kunststof/plastic/kunststoff	16A

CCS BOAT INLET

nr.		e.h.
355CCS10	32A/480V	1



CEE STEKKER (16A)

nr.		e.h.
3456325	CEE stekker	1
3456326	CEE contra stekker	1
3456327	Schuko adapter to CEE	



CEE STEKKER (32A)
SOCKET PLUG
CEE STECKER

nr.		e.h.
3456032	CEE stekker	1
3456132	CEE contra stekker	1



CCS BOAT INLET

nr.		e.h.
35532101	32A/400V	1



CLIPS T.B.V. WALSTROOM KABEL
CLIPS FOR POWER CABLE
KABELCLIPS FÜR LANDANSCHLUSSKABEL



nr.	omschrijving		verpakt per
70038	Railingclip	A	6
70040	Steigerclip 8mm	B	6

Ratio Solar 11-22 kW NIEUW - met gratis Ratio app

Slim thuisladen van je elektrische auto:

- ✓ Eenvoudig inzien en beheren van laadsessies in de app
- ✓ Groen laden met eigen opgewekte zonnestroom
- ✓ Veilig laden - standaard uitgerust met Dynamische Load Balancing

Verbonden, veilig en makkelijk thuis laden van je EV

Powered by simplicity
 Gebruiksvriendelijke Ratio app voor gebruikers én installateurs.

Made in Holland
 Duurzaam geproduceerd vanuit Nijkerk. Onze 5e generatie laadpaal is ontwikkeld op basis van meer dan 12 jaar ervaring in de EV markt. Ervaar de voordelen van het handige design en uitstekende service.

Voor meer informatie en verkooppunten:
ratio.nl

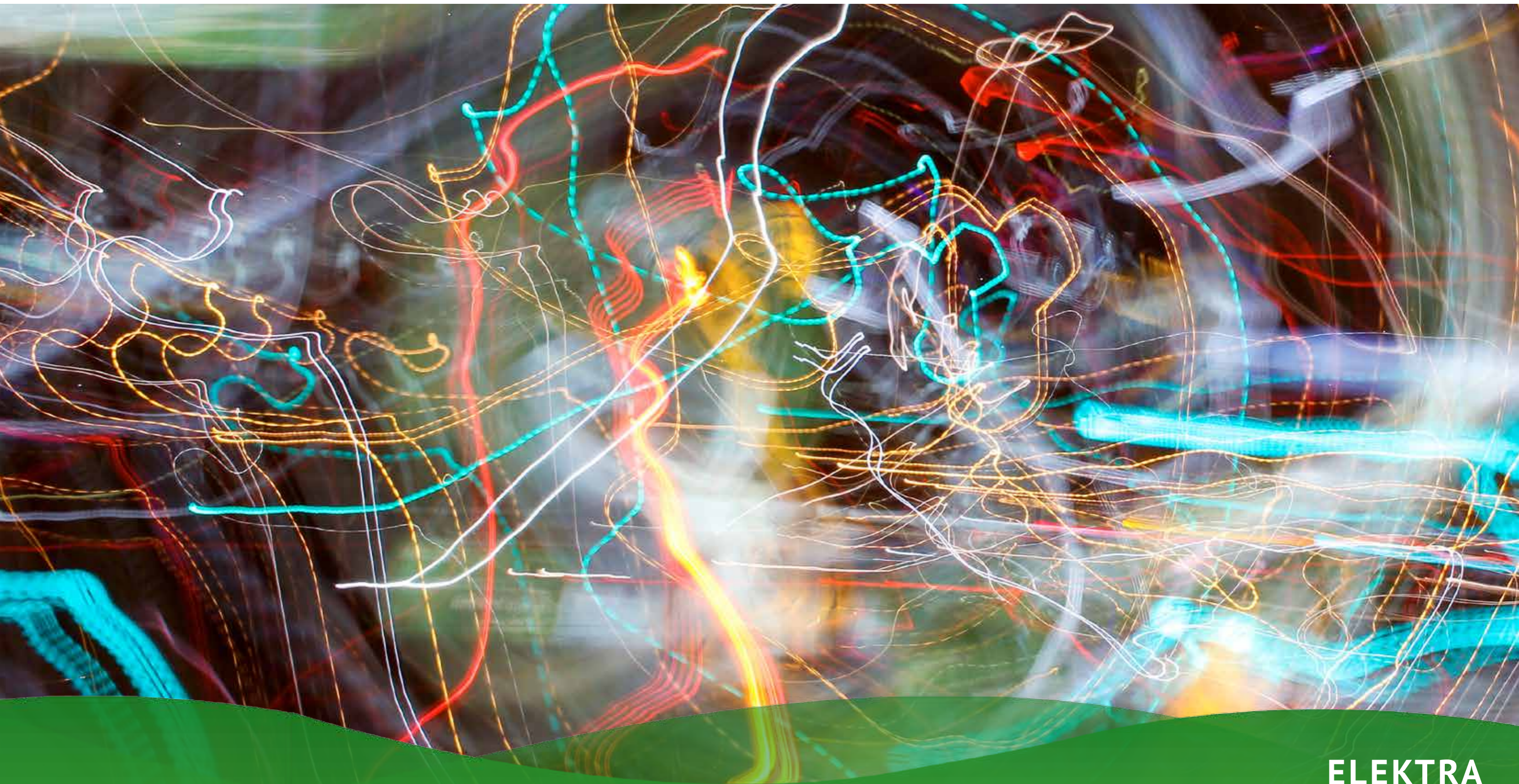

ELEKTRA
ELECTRICITY
ELEKTRO



KABELBESCHERMSLANG - DICHT
FLEXIBLE CORRUGATED TUBE - CLOSED
KABELSCHUTZSCHLAUCH - GESCHLOSSEN

nr.	∅ / Ø	haspel / reel / Rolle
946004	4/7,20	100
946006	6/9,60	100
946009	9/13,25	100
946011	11/16,40	100
946013	13/18,40	100
946016	16/21,15	50
946019	19/24,00	50
946023	23/28,60	50
946026	26/31,65	50
946029	29/35,90	50
946032	32/39,50	25



T-CONNECTOR

nr.		
946304	7,5 x 7,5 x 7,5 mm	1
946305	10 x 10 x 10 mm	1
946306	13 x 13 x 13 mm	1
946307	10 x 13 x 10 mm	1
946308	10 x 7,5 x 7,5 mm	1
946309	13 x 10 x 13 mm	1
946310	7,5 x 10 x 7,5 mm	1



KABELBESCHERMSLANG - OPEN
FLEXIBLE CORRUGATED TUBE - OPEN
KABELSCHUTZSCHLAUCH - OFFEN

nr.	∅ / Ø	haspel / reel / Rolle
946004.2	4/7,20	100
946006.2	6/9,60	100
946009.2	9/13,25	100
946011.2	11/16,40	100
946013.2	13/18,40	100
946016.2	16/21,15	50
946019.2	19/24,00	50
946023.2	23/28,60	50
946026.2	26/31,65	50
946029.2	29/35,90	50
946032.2	32/39,50	25



INSERTERTOOL

nr.	use for	
946400	8 mm	1
946401	15 mm	1
946402	20 mm	1
946403	32 mm	1



KABELBESCHERMSLANG - DICHT
FLEXIBLE CORRUGATED TUBE - CLOSED
KABELSCHUTZSCHLAUCH - GESCHLOSSEN

VOOR ELEKTRISCH VAREN / FOR ELECTRIC BOATS / FÜR E-BOTE

nr.	∅ / Ø	haspel / reel / Rolle
946011.4	11/15	100
946016.4	16/21	50
946021.4	21/25	50
946026.4	26/32	50
946032.4	32/39	50



GEWEVEN BESCHERMHOES
BRAIDED SLEEVE
GEFLECHTSCHLAUCH

Prijs per doos

nr.	mm	haspel / reel / Rolle
948006	6	500
948008	8	350
948010	10	350
948012	12	300
948020	20	200
948020/50	20	50
948020/100	20	100
948030	30	150
948050	50	100

nr.	mm	doos/box/karton
948003/10	3	10 meter
948006/10	6	10 meter
948008/10	8	10 meter
948010/10	10	10 meter
948012/8	12	8 meter
948020/8	20	8 meter
948030/5	30	5 meter
948050/3	50	3 meter



FLEX SPIRAAL KABELBESCHERMING
FLEXIBLE SPIRAL
FLEXIBLE SPIRALSCHLAUCH

nr.	mm	haspel / reel / Rolle
8881216	12x16	50
8882025	20x25	50
8882732	27x32	50
8883540	35x40	50



BEDRADINGSKOKER OPEN
WIRING DUET OPEN
VERDRÄHTUNGSKANAL OFFEN

nr.	↑	↔	doos/box/karton
3323453	40	40	26 x 2 meter
3323454	40	60	20 x 2 meter
3323456	60	30	26 x 2 meter
3323457	60	40	28 x 2 meter
3323458	60	60	18 x 2 meter
3323460	60	100	11 x 2 meter
3325368	80	60	12 x 2 meter

Andere maten op aanvraag leverbaar.

Other sizes available on request.

Andere Größen auf Anfrage erhältlich.

Verkoop alleen per volle doos i.v.m. transportschade

Only sale by box

Verkauf nur per volle Kartons möglich!

WILLEM-JANTJE



nr.		
584511	11cm	1 verpakking
584516	16cm	1 verpakking

Andere lengtes op aanvraag.



DELPHINUS KABELBESCHERMING
DELPHINUS PROTECTION HOSE
DELPHINUS KABELSCHUTZSCHLAUCH

nr.	∅	Ø	haspel / reel / rolle
4500035	35	41	50
4500038	38	45	50
4500050	50	57	50

KABELSCHOENEN CONFORM DIN 40500
POWER LUGS KABELSCHUHE



nr.	mm ²	gat/hole/loch	vpe/overdoos
3450606	6	M6	20/800
3450608	6	M8	20/800
3450610	6	M10	20/100
3451005	10	M	20/600
3451006	10	M6	20/600
3451008	10	M8	20/600
3451010	10	M10	20/100
3451012	10	M12	20/100
3451606	16	M6	20/400
3451608	16	M8	20/400
3451610	16	M10	20/400
3451612	16	M12	20/400
3452506	25	M6	20/250
3452508	25	M8	20/250
3452510	25	M10	20/250
3452512	25	M12	20/250
3453506	35	M6	20/150
3453508	35	M8	20/150
3453510	35	M10	20/150
3453512	35	M12	20/150
3455006	50	M6	10/120
3455008	50	M8	10/120
3455010	50	M10	10/120
3455012	50	M12	10/120
3455014	50	M14	10/120
3457006	70	M6	10/80
3457008	70	M8	10/80
3457010	70	M10	10/80
3457012	70	M12	10/80
3457014	70	M14	10/80
3457016	70	M16	10/80
3459508	95	M8	10/60
3459510	95	M10	10/60
3459512	95	M12	10/60
34512008	120	M8	10
34512010	120	M10	10
34512012	120	M12	10
34512014	120	M14	10
34512016	120	M16	10

nr.	mm ²	gat/hole/loch	vpe/overdoos
34515008	150	M8	10
34515010	150	M10	10
34515012	150	M12	10
34515016	150	M16	10
34518510	185	M10	10
34518512	185	M12	10
34518516	185	M16	10
34524010	240	M10	10
34524012	240	M12	10
34524014	240	M14	10
34524016	240	M16	10

KABELSCHOENEN 90 GRADEN
POWER LUGS
KABELSCHUHE



nr.	mm ²	gat/hole/loch	vpe
3441005	10	M5	5
3441006	10	M6	5
3441008	10	M8	5
3441010	10	M10	5
3441606	16	M6	5
3441608	16	M8	5
3441610	16	M10	5
3442506	25	M6	5
3442508	25	M8	5
3442510	25	M10	5
3443506	35	M6	5
3443508	35	M8	5
3443510	35	M10	5
3445006	50	M6	5
3445008	50	M8	5
3445010	50	M10	5
3445012	50	M12	5
3447008	70	M8	5
3447010	70	M10	5
3447012	70	M12	5
3449508	95	M8	5
3449510	95	M10	5
3449512	95	M12	5
34412010	120	M10	5

KABELSCHOEN 45 GRADEN **POWER LUGS** **KABELSCHUHE**

nr.	mm ²	gat/hole/loch	vpe
3421005	10	M5	5
3421006	10	M6	5
3421008	10	M8	5
3421606	16	M6	5
3421608	16	M8	5
3421610	16	M10	5
3422506	25	M6	5
3422508	25	M8	5
3422510	25	M10	5
3423506	35	M6	5
3423508	35	M8	5
3423510	35	M10	5
3425006	50	M6	5
3425008	50	M8	5
3425010	50	M10	5
3425012	50	M12	5
3427008	70	M8	5
3427010	70	M10	5
3427012	70	M12	5
3429508	95	M8	5
3429510	95	M10	5
3429512	95	M12	5



KABELSCHOENSTIFT
CABLE LUGS PIN
STIFT-KABELSCHUHE

nr.	omschrijving	vpe
346010	10 mm ²	5
346016	16 mm ²	5
346025	25 mm ²	5
346035	35 mm ²	5
346050	50 mm ²	5
346070	70 mm ²	5
346095	95 mm ²	5



DOORVERBINDER
HEAD POWER JOINT
KABELVERBINDER

nr.	omschrijving	vpe
3451000	10 mm ²	5
3451600	16 mm ²	5
3452500	25 mm ²	5
3453500	35 mm ²	5
3455000	50 mm ²	5
3457000	70 mm ²	5
3459500	95 mm ²	5
3451200	120 mm ²	5



KABELSCHOEN ALU BOLTED
POWER LUGS
KABELSCHUHE

nr.	mm ²	gat	vpe	bout
3481200	25 - 95	M12	5	1
3481201	35 - 150	M12	5	1
3481202	70 - 240	M12	5	2
3481203	120 - 300	M12	5	2
3481204	185 - 400	M12	5	3



KRIMPKOUS **HEATSHRINK TUBING** **SCHRUMPFSCHLAUCH**

nr.	omschrijving,	krimp/shrink		box
	<i>richtlijn geschikt voor</i>			
946040	1,2	0,6	●	15 meter
946042			●	15 meter
946050	1,6	0,8	●	15 meter
946052			●	15 meter
946055	2,4	1,2	●	13 meter
946077			●	13 meter
946060	3,2	1,6	●	12 meter
946062	1,5mm ²		●	12 meter
946080	4,8	2,4	●	11 meter
946082	2,5 en 4mm ²		●	11 meter
946100	6,4	3,2	●	10 meter
946102	4 en 6 mm ²		●	10 meter
946120	9,5	4,8	●	7 meter
946122	10 en 16mm ²		●	7 meter
946140	12,7	6,4	●	6 meter
946142	25mm ²		●	6 meter
946150	15,9	8	●	5 meter
946152	35mm ²		●	5 meter
946160	19,1	9,55	●	5 meter
946162	50 mm ²		●	5 meter
946180	25,4	12,7	●	4 meter
946182	70, 95, 120 mm ²		●	4 meter

MET LIJMLAAG **WITH GLUE LAYER** **MIT KLEBESCHICHT**

nr.	omschrijving,	krimp/shrink		box
	<i>richtlijn geschikt voor</i>			
9461032BL	3	1	●	5 meter
9461032RL	3	1	●	5 meter
9461048BL	4,8	1,6	●	4 meter
9461048RL	4,8	1,6	●	4 meter
9461064BL	6,4	2,1	●	3,5 meter
9461064RL	6,4	2,1	●	3,5 meter
9461079BL	7,9	2,6	●	3 meter
9461079RL	7,9	2,6	●	3 meter
9461095BL	9,5	3,2	●	3 meter
9461095RL	9,5	3,2	●	3 meter
9461127BL	12,7	4,2	●	2,5 meter
9461127RL	12,7	4,2	●	2,5 meter
9461150BL	15,4	5,1	●	2,5 meter
9461150RL	15,4	5,1	●	2,5 meter
9461191BL	19,1	6,4	●	2 meter
9461191RL	19,1	6,4	●	2 meter
9461254BL	25,4	8,4	●	1,5 meter
9461254RL	25,4	8,4	●	1,5 meter



Overige kleuren op aanvraag. Other colors on request. Weitere Farben auf Anfrage.

KABELSCHOEN TYPE DIN 46235 DYNAMIC VERSIE **POWER LUGS** **KABELSCHUHE**
 DIN 10 VOOR LANGERE KABELINVOER EN GROTERE KLEM/PER.

nr.	mm ²	gat/hole/loch	vpe/overdoos
3431608	16	M8	20/100
3431610	16	M10	20/100
3432508	25	M8	20/100
3432510	25	M10	20/100
3432512	25	M12	20/100
3433508	35	M8	20/100
3433510	35	M10	20/100
3433512	35	M12	20/100
3435008	50	M8	10/100
3435010	50	M10	10/100
3435012	50	M12	10/100
3435016	50	M16	10/100
3437006	70	M6	10/100
3437008	70	M8	10/100
3437010	70	M10	10/100
3437012	70	M12	10/100
3437016	70	M16	10/100
3439510	95	M10	10/100
3439512	95	M12	10/100
3439516	95	M16	10/100
34312010	120	M10	10/100
34312012	120	M12	10/100
34312016	120	M16	10/100
34312020	120	M20	10/100
34315010	150	M10	10/100
34315012	150	M12	10/100
34315016	150	M16	10/100
34315020	150	M20	10/100
34318510	185	M10	10/100
34318512	185	M12	10/100
34318516	185	M16	10/100
34318520	185	M20	10/100
34324008	240	M8	10/100
34324010	240	M10	10/100
34324012	240	M12	10/100
34324016	240	M16	10/100
34324020	240	M20	10/100
34330016	300	M16	10/100
34330020	300	M20	10/100
34340016	400	M16	10/100
34340020	400	M20	10/100
34350020	500	M20	10/100
34362520	625	M20	10/100





DIVERSE KRIMPINGEN CRIMPING TOOL

nr.	omschrijving
903050	tbv geïsoleerde gekleurde kabelschoen m/v
903060	tbv geïsoleerde kabelschoen ring/vork/pin
903070	hotseals
903080	Adereindhulzen 1,5mm - 4,0mm
903085	Adereindhulzen 6,0mm - 16,0mm



FÖHN VOOR HOTSEALS MET HITTE SCHILD

nr.	omschrijving	verp. eenheid
903090	Vulling d.m.v. wegwerp aansteker Filling by means of disposable lighter Befüllung mit Einwegfeurzeug	1st



PERSTANGEN PRESSING PLIERS PRESSZANGE

nr.	klembereik/clamping range/spanbereich
903460	6 t/m 50 mm ²
903470	10 t/m 120 mm ²



KABELSCHAAR CABLE CUTTER KABELSCHNEIDER

nr.	bereik/range/bereich
KM95	t/m 95mm ²
KM240	t/m 240mm ²
905010	tot 70mm ²



KABELSTRIPTANG CABLE STRIPPER ABISOLIERZANGE

nr.	bereik/range/bereich
4-28H	4 - 28 mm ²

ELEKTRISCHE PERSTANG ELECTRIC PRESSING PLIERS ELEKTRISCHE PRESSZANGE

10 - 300 MM² / 60 KN



nr.	omschrijving
3459898	Perstang/Pressing pliers/Presszange 6-150mm ² Klauke EK35/4 ML



3459090	Kabelsnijder/Cable cutter/Kabelschneider SFK 45
---------	---



HANDHYDRAULISCHE PERSTANG VOOR KABELSCHOENEN MANUALHYDRAULIC PRESSING TONGS FOR POWER LUGS MANUELLE HYDRAULISCHE PRESSZANGE FÜR KABELSCUHE

nr.		e.h.
903480	10mm ² - 240mm ²	1st

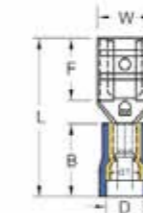

VLAKSTEKERHULS GEISOLEERD PRE ISOLATED BLADE CONNECTOR - FLACHSTECKHÜLSE ISOLIERT

nr.	EH	maat	W	F	L	B	D	d1
100020	100	2.8x0.8	3,2	6,5	19	10,5	3,8	1,7
100050	100	4.8x0.8	5	6,4	19,4	10,5	3,8	1,7
100100	100	6.3x0.8	6,6	7,5	20,8	10,5	3,8	1,7
152000	100	2.8x0.5	3,2	6,5	19	10,5	4,7	2,3
100380	100	4.8x0.5	5	6,4	19,4	10,5	4,7	2,3
100460	100	6.3x0.8	6,6	7,5	20,8	10,5	4,7	2,3
101000	100	6.3x0.8	6,6	7,5	23,3	13	6,2	3,4



VLAKSTEKERHULS VOLLEDIG GEISOLEERD FULLY ISOLATED BLADE CONNECTOR FLACHSTECKHÜLSE VOLLISOLIERT

nr.	EH	maat	W	F	L	B	D	d1
101270	100	6.3x0.8	6,6	7,5	21,8	10,5	3,8	1,7
101310	100	6.3x0.8	6,6	7,5	22,2	10,5	4,7	2,3
101320	100	6.3x0.8	6,6	7,5	24,2	12,5	6,2	3,4

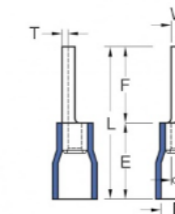

PENSTEKER MALE PLUGS PRE ISOLATED - STIFTKABELSCHUH ISOLIERT

nr.	EH	W	F	L	E	D	d1	T
100160	100	1.9	10	19,8	10	4	1,7	0,75
100550	100	1,9	12	21,8	10	4,5	2,3	0,8
101050	100	2.7	14	27	13	6,4	3,4	1,0

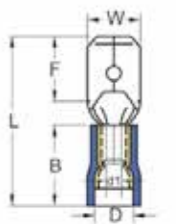

VLAKSTEKER FLAT PLUG - FLACHSTECKER ISOLIERT

nr.	EH	maat	W	F	L	B	D	d1
100030	100	2.8x0.8	2,8	6,6	19,2	10,5	3,8	1,7
100110	100	6.3x0.8	6,3	7,7	21,8	10,5	3,8	1,7
100480	100	6.3x0.8	4,8	6,7	19,8	10,5	4,7	2,3
100990	100	6.3x0.8	6,3	7,7	24	13	6,2	3,4

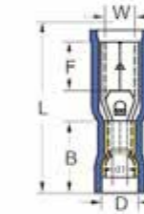

RONDSTEKERHULS FEMALE ROUND PLUG - RUNDSTECKER BUCHSE VOLLISOLIERT

nr.	EH	W	F	L	B	D	d1
100090	100	3,9	7	23,3	10,5	3,8	1,7
100450	100	4,9	7	23,3	10,5	4,7	2,3
100980	100	4,9	7	25,1	12,5	6,2	3,4

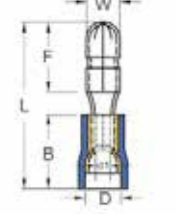

RONDSTEKER MALE CILINDRED TERMINAL MALE - RUNDSTECKER STIFT ISOLIERT

nr.	EH	W	F	L	B	D	d1
100080	100	4	8,5	21,5	10,5	3,8	1,7
100440	100	5	8,5	21,2	10,5	4,7	2,3
100970	100	5	8,5	24	13	6,2	3,4

GEISOLEERDE VLAKSTEKERHULS MET EXTRA TAB PIGGY BACK - DOPPELFLACHSTECKERHÜLSE ISOLIERT

nr.	EH	maat	W	W1	F	F1	L	B	D	d1
100120	100	6.3x0.8	6,6	6,35	8	8,2	22,5	10,5	3,8	1,7
100470	100	6.3x0.8	6,6	6,35	8	8,2	22,5	10,5	4,7	2,3
101005	100	6.3x0.8	6,6	6,35	8	8,2	24	13	6,2	3,4

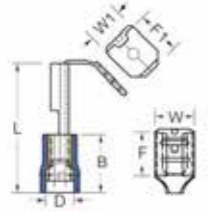



**RINGKABELSCHOEN
PRE ISOLATED EYE - RINGKABELSCHUH ISOLIERT**

nr.	EH	d2	d3	l	d1	d4	a	S
100180	100	3,2	6	16	1,6	4	10	0,8
100270	100	4,3	8	17	1,6	4	10	0,8
100320	100	5,3	10	18	1,6	4	10	0,8
100350	100	6,5	10	18	1,6	4	10	0,8
100360	100	8,4	14	22	1,6	4	10	0,8
100140	100	10,5						0,8
100590	100	3,2	6	16	2,3	4,5	10	0,8
100680	100	4,3	8	17	2,3	4,5	10	0,8
100730	100	5,3	10	19	2,3	4,5	10	0,8
100770	100	6,5	11	21	2,3	4,5	10	0,8
100780	100	8,4	14	22	2,3	4,5	10	0,8
100510	100	10,5	15	22	2,3	4,5	10	0,8
101100	100	4,3	8	21	3,6	6,3	13	1
101150	100	5,3	10	22	3,6	6,3	13	1
101180	100	6,5	11	22	3,6	6,3	13	1
101200	100	8,4	14	26	3,6	6,3	13	1
101030	100	10,5	18	28	3,6	6,3	13	1

**DOORVERBINDER - HEAD-HEAD JUMPER - STOSSVERBINDER
ISOLIERT**

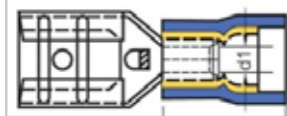
nr.	EH	maat	L	D	d1
100170	100	4.0	24,6	4	1,7
100580	100	4.5	24,6	4,5	2,3
101120	100	6.8	26,5	6,3	3,4

KLEURCODE / COLOR CODE / FARBCODE

Voor kabel / for cable/ für Kabel

- 0,5 - 1,5 mm²
- 1,0 - 2,5 mm²
- 2,5 - 6 mm²

Alle uitvoeringen zijn Easy entry - All with Easy entry
Alle Versionen mit Easy entry

**RECHTE VORK KABELSCHOEN
PRE ISOLATED FORKEYE - GABELKABELSSHUH ISOLIERT**

nr.	EH	d2	d3	l	d1	d4	a	S
100640	100	4,3	6,8	17	2,3	4,5	10	0,8
100700	100	5,3	10	19	2,3	4,5	10	0,8
100740	100	6,4	11	21	2,3	4,5	10	0,8
101080	100	4,3	8	21	3,6	6,3	13	1
101110	100	5,3	10	22	3,6	6,3	13	1
101160	100	6,4	11	23	3,6	6,3	13	1

**ADEREINDHULZEN DINTYPE
FERRULES - ADERENDHÜLSEN**

nr.	EH	mm ²	F	L	B	D	C
720030/100	100	0,75	8	14	6,3	1,5	1,2
720040/100	100	1	8	14	6,3	1,7	1,4
720050/100	100	1.5	8	14	6,3	2	1,7
720051/100	100	1.5	15	14	6,3	2	1,7
720060/100	100	2.5	8	15	7,4	2,5	2,2
720061/100	100	2.5	18	15	7,4	2,5	2,2
720070/100	100	4	10	17	7,4	3,2	2,8
720080/100	100	6	12	20	8,5	3,9	3,5
720090/100	100	10	12	22	8,8	4,9	4,5

**ADEREINDHULZEN DUBBEL
FERRULES DOUBLE - DOPPELADERENDHÜLSEN**

nr.	EH	mm ²	F	L	B	D	C
720015/100	100	2x0,50	8	14	6,5	1,8	1,4
720035/100	100	2x0,75	8	14,7	6,7	2,1	1,8
720045/100	100	2x1	8	15,1	7,1	2,4	2,1
720055/100	100	2x1.5	8	15,5	7,5	2,6	2,3
7200225/100	100	2x2.5	10	18,5	8,5	3,3	2,9
720075/100	100	2x4	12	23,1	11,1	4,2	3,8
720085/100	100	2x6	14	26,1	12,1	5,3	4,9

RINGKABELSCHOEN - RING CABLE LUG - RINGKABELSCHUH

nr.	EH	mm ²	d2	W	L
1735015	100	0.5-1.5	5.3	8	32.8
1735016	100	0.5-1.5	6.4	11.6	38
1735018	100	0.5-1.5	8.4	11.6	38
1735010	100	0.5-1.5	10.5	13.6	41.6
1735025	100	1.5-2.5	5.3	9.5	31.8
1735026	100	1.5-2.5	6.4	12	37.5
1735028	100	1.5-2.5	8.4	12	36
1735030	100	1.5-2.5	10.5	13.6	40.2
1735056	100	4-6	6.4	12	39.4
1735058	100	4-6	8.4	15	44
1735060	100	4-6	10.5	15	44

RONDSTEKER MALE - ROUND LUG - RUNDSTECKER BUCHSE

nr.	EH	mm ²	W	D	L
1760055	100	0.5-1.5	4.0	5.5	33
1760060	100	1.5-2.5	5.0	6.0	33

RONDSTEKER FEMALE - ROUND LUG - RUNDSTECKER BUCHSE

nr.	EH	mm ²	W	D	L
1760056	100	0.5-1.5	4.0	5.5	33
1760061	100	1.5-2.5	5.0	6.0	33

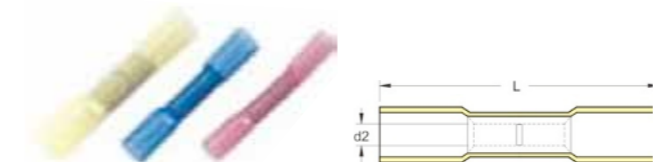
DOORVERBINDER - JUMPER - STOSSVERBINDER

nr.	EH	mm ²	d2	L
1710800	100	0.5-1.5	1.7	36
1720800	100	1.5-2.5	2.3	36
1730800	100	4-6	3.4	41

VLAKSTEKERHULS - FLAT LUG SLEEV - FLACHSTECKHÜLSE

nr.	EH	mm ²	W	D	L
1740055	100	0.5-1.5	6.6	5.5	34
1740060	100	1.5-2.5	6.6	6.0	34
1735081	100	0.5-1.5	8.4	11.6	38

HOTSEAL VLAKSTEKER - FLAT LUG - FLACHSTECKER

nr.	EH	mm ²	W	D	L
1745055	100	0.5-1.5	6.6	5.5	34
1745060	100	1.5-2.5	6.6	6.0	34
1745081	100	4-6	6.6	8.1	35

**VLAKSTEKER VOLLEDIG GEISOLEERD
FLAT LUG FULLY INSULATED - FLACHSTECKER VOLLISOLIERT**

nr.	EH	mm ²	W	D	L
1765065	100	0.5-1.5	6.35	6.5	38.5
1765070	100	1.5-2.5	6.35	6.5	39.5
1765075	100	4-6	6.35	7.5	39.5

KLEURCODE / COLOR CODE / FARBCODE

Voor kabel / for cable/ für Kabel

- 0,5 - 1,5 mm²
- 1,0 - 2,5 mm²
- 2,5 - 6 mm²

Alle uitvoeringen zijn Easy entry - All with Easy entry
Alle Versionen mit Easy entry



**MOLEX CONNECTOR STEKKER
MALE CONNECTOR
BUCHSENGEHÄUSE MÄNNLICH**

KUNSTSTOF BEHUIZING

nr.

10005005	2-polig
10005007	4-polig
10005009	6-polig
10005011	8-polig



**MOLEX PIN STEKKER
MALE CONNECTION
CRIMPKONTAKT MÄNNLICH**

nr. omschrijving

10005013	Te gebruiken in connector stecker. For use in connector plug. Zur Verwendung mit Buchsengehäuse.
----------	--



**WATERDICHT VERBINDING
WATERTIGHT CONNECTOR
WASSERDICHT STECKVERBINDUNG**

Verpakt per zakje / packed in bag / pro Beutel verpackt

nr.

991000501	Connector F+M, terminal F+M, 2x wire seals
991000502	Connector F+M, 2 x terminal F+M, 4 x wire seals
991000503	Connector F+M, 3 x terminal F+M, 6 x wire seals
991000504	Connector F+M, 4 x terminal F+M, 8 x wire seals
991000505	Connector F+M, 5 x terminal F+M, 10 x wire seals
991000506	Connector F+M, 6 x terminal F+M, 12 x wire seals
991000509	Superseal tang set incl. bekjes
991000510	Superseal contact krimptang
99100511	Superseal connector krimpbekjes 0,35 - 0,5 mm²
99100512	Superseal connector krimpbekjes 0,75 - 1 mm²



**MOLEX CONNECTOR CONTRA
CONNECTOR CONTRA
BUCHSENGEHÄUSE WEIBLICH**

KUNSTSTOF BEHUIZING

nr.

10005004	2-polig
10005006	4-polig
10005008	6-polig
10005010	8-polig



**MOLEX PIN CONTRA
FEMALE CONNECTION
CRIMPKONTAKT WEIBLICH**

nr. omschrijving

10005012	Te gebruiken in connector contra. For use in connector contra. Zur Verwendung mit Buchsengehäuse.
----------	---



WAGO COMPACT

nr.	mm²		vpe
42-2212411	1	kabel tot 4 mm	60
42-222412	2	kabel tot 4 mm	100
42-222413	3	cable up to 4 mm	50
42-222415	5	Kabel bis zum 4 mm	25

Bekijk onze website voor alle wago artikelen.

Visit our website for other wago items.

Bitte schauen sie auf unsere homepage für weitere wago artikel.



GELBOX

WATERDICHT - WATERTIGHT - WASSERDICHT

nr. Te gebruiken met compact / For use with compact / vpe

nr.		Zur Verwendung mit WAGO Compact	vpe
42-333412	42-222412		4
42-333413	42-222413		4
42-333415	42-222415		3



**RVS KABELBANDJES
STAINLESS STEEL CABLE TIE
EDELSTAHL KABELBINDER**



nr.	breedte x lengte	verp.eenheid
5800125	4,5 x 125	100
5800200	4,5 x 200	100
5800360	4,5 x 360	100
5800520	4,5 x 520	100
5800680	4,5 x 680	100
5800840	4,5 x 840	100
5800152M	8,0 x 152	50
5800200M	8,0 x 200	50
5800360M	8,0 x 360	50
5800520M	8,0 x 520	50
5800680M	8,0 x 680	50
5800840M	8,0 x 840	50



**SCHROEFZADELS WIT
CLAMP SUPPORTS
BEFESTIGUNGS SOCKEL FÜR KABELBINDER**

nr.		verp. eenheid
952315	klein / small / klein	100
951510	groot / big / gross	100



**SCHROEFZADELS ZWART
CLAMP SUPPORTS
BEFESTIGUNGS SOCKEL FÜR KABELBINDER**

nr.		verp. eenheid
962315	klein / small / klein	100
961510	groot / big / gross	100



**KABELBANDJES
CABLE TIES
KABELBINDER**

nr.	kleur	breedte x lengte	verp.eenheid
580020	○	2,5 x 98	100
580060	○	2,6 x 200	100
580080	○	3,6 x 140	100
580100	○	3,6 x 200	100
580130	○	4,5 x 160	100
580150	○	4,8 x 200	100
580180	○	4,8 x 360	100
580290	●	2,5 x 100	100
580330	●	2,5 x 203	100
580350	●	3,6 x 142	100
580360	●	4,8 x 160	100
580370	●	3,6 x 203	100
580400	●	4,6 x 160	100
580420	●	4,6 x 203	100
580430	●	4,8 x 290	100
580450	●	4,8 x 360	100
580470	●	7,6 x 370	100
580480	●	7,8 x 300	100
580490	●	7,6 x 450	100
580780	●	7,8 x 540	100



**PLAKZADELS
STICKY SADDLES FOR CABLE TIES
KLEBESOCKEL FÜR KABELBINDER**

nr.	b x l mm	kleur	verp. eenheid
580260	19 x 19	○	100
580270	27 x 27	○	100



**KABELBAND MET SCHROEF OOG
CABLE TIE WITH SCREW EYE
KABELBINDER MIT BEFESTIGUNGSÖSE**

nr.	b x l mm	kleur	verp. eenheid
581110	2,5 x 110	○	100
581150	3,6 x 150	○	100
581200	4,8 x 200	○	100
581201	7,8 x 200	○	100
581313	7,6 x 313	○	100
581382	7,6 x 382	○	100

ACCUPOL KLEMMEN **BATTERY TERMINALS** **BATTERIEPOLKLEMMEN**

AFDEKKAPPEN BLZ 46 - ISOLATING CAPS PAGE 46 - SCHUTZKAPPEN FÜR BATTERIEPOLKLEMMEN SEITE 46



nr.	pool	te gebruiken met	vpe
3323555	+	16 - 35 mm ²	10
3323556	-	16 - 35 mm ²	10
3323566	+	50 - 70 mm ²	10
3323567	-	50 - 70 mm ²	10

MET M10 DRAADEIND
WITH M10 THREADED END
MIT M10 GEWINDEENDE

nr.	pool	te gebruiken met	vpe
3313569	+	m10 kabelschoen-	10
3323568	-	ogen	10

MET M10 BOUT
WITH M10 BOLT
MIT M10 BOLZEN

nr.	pool	te gebruiken met	vpe
3388569	+	m10 kabelschoen-	10
3388568	-	ogen	10

EASY CLICK / MIT SCHNELLVER-
SCHLUSS

nr.	kleur	pool
4703000	●	+
4703050	●	-
4703100	●	-

DUBBEL
DOUBLE
DOPPELT

nr.	pool	te gebruiken met	vpe
3388672	+	50 - 70 mm ²	10
3388682	-	50 - 70 mm ²	10

MET MASSA ONDERBREKER
WITH GROUND BREAKER
BATTERIETRENNSCHALTER

nr.	e.h.
3323444	1



nr.	vpe
9660666 Accuklem voor blokkeering horizontale positie	1
9660667 Accuklem voor blokkeering verticale positie	1



nr.	vpe
9660050 Blokkeering 50 amp	1
9660100 Blokkeering 100 amp	1
9660125 Blokkeering 125 amp	1
9660150 Blokkeering 150 amp	1
9660175 Blokkeering 175 amp	1
9660200 Blokkeering 200 amp	1
9660250 Blokkeering 250 amp	1
9660300 Blokkeering 300 amp	1



nr.	vpe
9660660 Isolatiemoer M8	1

OPZETPOLEN
VOOR AGM- EN GEL-ACCU'S

nr.	set
Mrt 5555	M5 (set + en -)
Mrt 6666	M6 (set + en -)
Mrt 8888	M8 (set + en -)

HOOFDSTROOM SCHAKELAARS ON/OFF
HEAVY DUTY MAINE BATTERY SWITCH
BATTERIE HAUPTSCHALTER

nr.	
97501	Continue/Dauerbetrieb 280A 5 sek/sec 2500A
97501S	Losse sleutel / sparekey / Ersatzschlüssel

HOOFDSTROOM SCHAKELAARS ON/OFF
EASY BATTERY SWITCH
BATTERIE HAUPTSCHALTER EINFACH

nr.	
97555	Continue/Dauerbetrieb 100A 5 sek/sec 500A
97555S	Losse sleutel / sparekey / Ersatzschlüssel

HOOFDSTROOM SCHAKELAARS ON/OFF
BATTERY SWITCH
BATTERIE HAUPTSCHALTER

nr.	
97525	Continue/Dauerbetrieb 250A 5 sek/sec 2500A
97526	Continue/Dauerbetrieb 250A 5 sek/sec 1000A

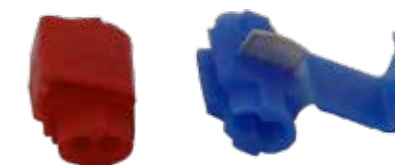
ZELFSTRIPPENDE AFTAKKLEM
QUICK SPLICE TERMINALS
SCHWACHSTROMVERBINDER FLEXIBEL

nr.	mm ²	
1000100	1,5 - 2,5	●
1000200	0,5 - 1	●





STARTKLEM
STARTING CLAMP
BATTERIEPOLZANGE

nr.		
4700011	50A	●
4700012	50A	●



STARTKLEM
STARTING CLAMP
BATTERIEPOLZANGE

nr.		
4700013	100-300A	●
4700014	100-300A	●



STARTKLEM
STARTING CLAMP
BATTERIEPOLZANGE

nr.		
4700003	120A	●
4700004	120A	●



STARTKLEM
STARTING CLAMP
BATTERIEPOLZANGE

nr.		
4700015	400A	●
4700016	400A	●



STARTKLEM
STARTING CLAMP
BATTERIEPOLZANGE

nr.		
4700017	500-600A	●
4700018	500-600A	●



STARTKLEM
STARTING CLAMP
BATTERIEPOLZANGE

nr.		
4700005	600A	●
4700006	600A	●



STARTKLEM
STARTING CLAMP
BATTERIEPOLZANGE

nr.		
4700019	700-1000A	●
4700020	700-1000A	●



STARTKLEM
STARTING CLAMP
BATTERIEPOLZANGE

nr.		
4700001	850A	●
4700002	850A	●



KAP VOOR SB50 WATERDICHT TE MAKEN
CAP FOR MAKING WATERTIGHT SB 50
WASSERDICHT ABDECKKAPPE FÜR SB50

♀ VROUW/FEMALE/WEIBLICH ♂ MAN/MALE/MÄNNLICH

nr.		e.h	
9588850/KAP	♀	IP65, Werktemp: -40 >35	1
9588850KAP/M	♂	16	1



BATTERIJ STEKKERS
BATTERY CONNECTORS
BATTERIESTECKER

2 STUKS / PIECES / STÜCK

nr.		mm ²	
9588850/G	SB50 ●	16	
9588850/R	SB50 ●	16	
9588175/G	SB175 ●	50	
9588175/R	SB175 ●	50	
9588350/G	SB350 ●	70	



CERTOPLAST PVC TAPE

nr.	rol / reel / Rolle	vpe
9992602	25 mtr ●	8
9992601	25 mtr ●	8

Overige kleuren op aanvraag.
Other colors on request.
Weitere Farben auf Anfrage.



TAPE TBV DASHBOARD
TAPE FOR ENGINE ROOM
KLEBAND FÜR MASCHINENRAUM

nr.	
9992514	textiel tape
9992538	fleece tape

MG '86

nr.
DGR-Spray Multispray

Multifunctioneel siliconenvrije vochtverrijver, elektro cleaner, contactspray, vermindert ook wrijvingsweerstand, lost ook corrosie op, verwijdert tevens tectyl, parafinne en vliegroest.

Multifunctional silicone-free moisture repeller, electro cleaner, contact spray also reduces frictional resistance also dissolves corrosion also removes tectyl, paraffin and flash rust.

Multifunktionaler, silikonfreier Feuchtigkeitsabweiser, Elektroreiniger und Kontaktspray, reduziert auch den Reibungswiderstand, löst Korrosion auf und entfernt Tektyl, Paraffin und Blitzrost.



HPX STETCH AND FUSE TAPE

nr.		vpe
9992301	25mm x 3m ●	1
9992302	25mm x 3m ○	1



STEEKZEKERINGHOUDER
ATO MET CENTRALE AANVOER INCL. LED

FUSEHOLDERBOX
WITH COMMON POSITIVE AND LED

STECKSICHERUNGSHALTER
MIT GEMEINSAMEM PLUSPOL UND LED

Per circuit 30A max totaal 100A

nr.	
4202041	4 voudig/contacts/kontakte
4202061	6 voudig/contacts/kontakte
4202101	10 voudig/contacts/kontakte



STEEKZEKERINGHOUDER
ATO, WATERDICHT MET LED

BLADE FUSEHOLDER
WATERPROOF AND LED

STECKSICHERUNGSHALTER
WASSERDICHT MIT LED

Per circuit 30A max totaal 100A

nr.	
4202810	10 voudig/contacts/kontakte



STEEKZEKERINGHOUDER
MET DUBBELE INVOER EN 1 CENTRALE MIN

FUSEHOLDERBOX
WITH DOUBLE+ AND 1-

STECKSICHERUNGSHALTER
MIT 2 MAL+ UND 1 MAL-

Per circuit 30A max totaal 100A

nr.	
4203206	6 voudig/contacts/kontakte



ZEKERINGHOUDER
ATO LED 4 VOUDIG

FUSEHOLDER
ATO LED 4 CONNECTIONS

SICHERUNGSHALTER
ATO LED 4-FACH

Per circuit 30A max totaal 100A

nr.	e.h.
4203004	1



ZEKERINGHOUDER
ATO LED 6 VOUDIG

FUSEHOLDER
ATO LED 6 CONNECTIONS

SICHERUNGSHALTER
ATO LED 6-FACH

Per circuit 30A max totaal 100A

nr.	e.h.
4203006	1



ZEKERINGHOUDER
ATO LED 10 VOUDIG

FUSEHOLDER
ATO LED 10 CONNECTIONS

SICHERUNGSHALTER
ATO LED 10-FACH

Per circuit 30A max totaal 100A

nr.	e.h.
4203010	1



ZEKERINGHOUDER
ATO DOORLUS 4 VOUDIG

FUSEHOLDER
ATO 4 CONNECTIONS

SICHERUNGSHALTER
ATO 4-FACH

nr.	e.h.
4213004	1



ZEKERINGHOUDER
ATO DOORLUS 6 VOUDIG

FUSEHOLDER
ATO 6 CONNECTIONS

SICHERUNGSHALTER
ATO 6-FACH

nr.	e.h.
4213006	1



ZEKERINGHOUDER
ATO DOORLUS 10 VOUDIG

FUSEHOLDER
ATO 10 CONNECTIONS

SICHERUNGSHALTER
ATO 10-FACH

nr.	e.h.
4213010	1



ZEKERINGHOUDER
ATO MET LED EN BUSHBAR
6 VOUDIG

FUSEHOLDER
ATO WITH LED AND BUSHBAR
6 CONNECTIONS

SICHERUNGSHALTER
ATO MIT LED UND BUSHBAR
6-FACH

nr.	e.h.
42023006	1



ZEKERINGHOUDER
ATO MET LED EN BUSHBAR
10 VOUDIG

FUSEHOLDER
ATO WITH LED AND BUSHBAR
10 CONNECTIONS

SICHERUNGSHALTER
ATO MIT LED UND BUSHBAR
10-FACH

nr.	e.h.
42023010	1



ZEKERINGHOUDER
MET SCHROEFVERBINDING
2 PLUS AANSLUITING + 1 MASSA

FUSEHOLDER
THREADED CONNECTION
2 PLUS + 1 MAS

SICHERUNGSHALTER
MIT SCHRAUBVERBINDUNG UND LED
2 MAL PLUS UND 1 MAL MASSE

nr.		e.h.
4212006	6-polig	1
4212012	12-polig	1

KIJK OP ONZE WEBSITE VOOR MEER INFORMATIE OVER NIEUWE PRODUCTEN EN DOWNLOAD TECHNISCHE DATASHEETS.

VISIT OUR WEBSITE FOR MORE INFORMATION ABOUT NEW PRODUCTS AND DOWNLOAD TECHNICAL DATASHEETS.

BITTE SCHAUEN SIE AUF UNSERE HOMEPAGE FÜR WEITERE INFOS ZU NEUEN PRODUKTEN UND ZUM HERUNTERLADEN TECHNISCHER DATENBLÄTTER.

**AFTAK ZEKERINGHOUDER
ADD A CIRCUIT FUSEHOLDER
SICHERUNGSHALTER MIT
ABZWEIG**

nr	omschrijving	per
120170	Standaard zekering	10

**STEEKZEKERING
BLADE FUSES
FLACHSTECKSICHERUNG**

ATO, PACKAGE 100

nr.	kleur	ampère
630010	Zwart	1A
630020	Grijs	2A
630030	Paars	3A
630040	Roze	4A
630050	Oranje	5A
630075	Bruin	7,5A
6300100	Rood	10A
6300150	Licht blauw	15A
6300200	Geel	20A
6300250	Transparant	25A
6300300	Donker groen	30A
6300350	Paars	35A
6300400	Licht rood	40A

**MICRO ZEKERINGEN
MICRO FUSE
MICRO SICHERUNG**

nr.	kleur	vpe	ampère
2992105	Bruin	100	5A
2992100	Rood	100	10A
2992150	Blauw	100	15A
2992200	Geel	100	20A

**ATO ZEKERING TREKKER
FUSE PULLER
SICHERUNGSZIEHER**

MET / WITH / MIT TESTER

nr	e.h.
640011	1

**ZEKERING TREKKER
FUSE PULLER
SICHERUNGSZIEHER**

nr	e.h.
640010	1

**STANDAARD STEEKZEKERINGHOUDER MET DRAAD
FUSEHOLDER WITH CABLE
SICHERUNGSHALTER MIT KABEL**

WATERDICH / WATERTIGHT / WASSERDICHT

nr	mm ²	vpe
120160	0,50 mm ² draad / cable / Kabel	10
120159	0,75 mm ² draad / cable / Kabel	10
120158	1 mm ² draad / cable / Kabel	10
120157	2 mm ² draad / cable / Kabel	10
120156	3 mm ² draad / cable / Kabel	10

**ZEKERINGHOUDER
MET VLAKSTEKER AAN TE SLUITEN**

**FUSEHOLDER
FOR FLAT PLUG**

**SICHERUNGSHALTER
FÜR FLACHSTECKER**

nr	vpe
120154	10 stuks/pieces/Stück

**AFTAK ZEKERINGHOUDER
T.B.V. MICROZEKERING**

**ADD A CIRCUITBREAKER
FOR MICROFUSE**

**MICRO SICHERUNGSHALTER
MIT ABZWEIG**

nr	e.h.
120173	1

**ANL ZEKERINGHOUDERS
FUSEHOLDER
ANL SICHERUNGSHALTER**

MET AFDEKKAP

WITH PROTECTION COVER

MIT SCHUTZKAPPE



nr.	type	max ampère
2581010	enkel	250A



nr.	type	max ampère
2581012	dubbel	250A



nr.	type	max ampère
800740	enkel	250A



nr.	type	max ampère
2581020	enkel, koppelbaar single but linkable Einzel, verlinkbar	500A



**ANL ZEKERINGHOUDER
MET AFDEKKAP + RESERVE ANL HOUDER
FUSEHOLDER SPAREFUSE
ANL SICHERUNGSHALTER
FÜR EXTRA SICHERUNG**

nr.	type	max ampère
2581011	enkel	250



**ANL ZEKERINGEN
ANL FUSES
ANL STREIFENSICHERUNG MIT KERAMIKGEHÄUSE
DC 80V**

nr.	ampère
95805035	35A
95805040	40A
95805050	50A
95805063	63A
95805080	80A
95805100	100A
95805125	125A
95805135	135A
95805160	160A
95805175	175A
95805200	200A
95805225	225A
95805250	250A
95805275	275A
95805300	300A
95805355	355A
95805375	375A
95805400	400A
95805425	425A
95805500	500A



**ANL ZEKERINGHOUDER VOOR 6 ANL ZEKERINGEN
FUSEHOLDER FOR 6 ANL FUSES
SICHERUNGSHALTER FÜR 6 ANL SICHERUNGEN**

nr.	type
2581016	6-voudig 123 mm x 252 mm



MINI ZEKERINGEN
MINI FUSES
MINI SICHERUNG

nr.	kleur	ampère
2991030	■	3
2991050	■	5
2991075	■	7,5
2991100	■	10
2991150	■	15
2991200	■	20
2991250	○	25
2991300	■	30



MINI AFTAKKLEM ZEKERINGHOUDER
MINI ADD A CIRCUIT BREAKER
MINI SICHERUNGSHALTER MIT ABZWEIG

nr.	omschrijving
120171	Aftakklem zekering voor mini zekering
120172	Aftakklem zekering voor low profile mini zekering



MIDI ZEKERING 58V
MIDI FUSES 58V
MIDI SICHERUNG 58V

nr.	kleur	ampère
9440030	■	30
9440040	■	40
9440050	■	50
9440060	■	60
9440080	○	80
9440100	■	100

MIDI ZEKERINGHOUDER
MIDI FUSE HOLDER
MIDI SICHERUNGSHALTER

nr	max DC 48V	M5
9440444		



MEGA ZEKERINGEN
HIGH CAPACITY FUSE
MEGA SICHERUNG

32V

nr.	kleur	ampère
9550040	●	40
9550050	●	50
9550060	●	60
9550080	■	80
9550100	■	100
9550125	■	125
9550150	■	150
9550175	○	175
9550200	■	200
9550225	■	225
9550250	■	250
9550300	■	300
9550400	■	400
9550500	■	500

MEGA ZEKERING
MEGA FUSE
MEGA SICHERUNG

70V, M8

nr.	kleur	ampère
9551080	■	80
9551100	■	100
9551125	■	125
9551150	■	150
9551175	○	175
9551200	■	200
9551225	■	225
9551250	■	250
9551300	■	300
9551350	■	350
9551400	■	400
9551450	■	450
9551500	■	500



MEGA ZEKERINGHOUDERS
HIGH CAPACITY FUSEHOLDER
MEGA SICHERUNGSHALTER
MET AFDEKKAP / WITH PROTECTION CAP / MIT SCHUTZKAPPE

nr.	
9550555	Megazekeringhouder (L: 11, B:9, H:4)
9550666	1 x Mega > 4 x midi



MAXI STEEKZEKERINGHOUDER
MAXI FUSE HOLDER
MAXI SICHERUNGSHALTER
MET KABEL / WITH CABLE / MIT KABEL

nr
120154.3



MAXI ZEKERING
MAXI FUSE
MAXI SICHERUNG

nr.	kleur	ampère
6300020	■	20
6300030	■	30
6300040	■	40
6300050	■	50
6300070	■	70
6300080	○	80
63000100	■	100



MAXI ZEKERINGHOUDER
MAXI FUSEHOLDER
MAXI SICHERUNGSHALTER

nr	omschrijving
120154.2	met afdekkap with protection cap mit Schutzkappe



BOOSTER CONTACT PUNTEN

Max. : 48 vdc.

Max. : 350 amp @ 12 vdc

nr.		bout / bolt /bolzen
800376/r	●	M10
800376/z	●	M10



BRACKET MOUNT KIT

nr.		bout / bolt /bolzen
800378/z		M10

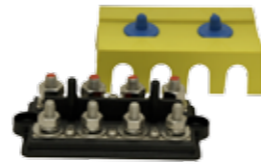

DUBBELVOUDIGE VERDEELSTRIP HEAVY DUTY BUSBAR TERMINAL SAMMELSCHIENE

+ EN - / + AND - / PLUS UND MINUS

nr.		e.h.
800738	4 x + M10/ 4 x - M8	1
800738/K	Kap voor verdeelstrip	1



HEAVY DUTY VERDEELSTRIP HEAVY DUTY BUSBAR TERMINAL HEAVY DUTY SAMMELSCHIENE

nr.		vdc	max vdc	eh
8007753/r	●	12-48	12V@700A	1
8007753/z	●	12-48	12V@700A	1
8007753/r KAP	●	12-48		1
8007753/z KAP	●	12-48		1



T-ZEKERINGHOUDER MET KAP BESTEMD VOOR JIN ZEKERING CLASS T FUSEHOLDER WITH PROTECTION CAP FOR JIN FUSES T SICHERUNGSHALTER FÜR JIN SICHERUNG

nr.		vdc
958735N8N14	●	12-48 vdc
958735N8N02	●	12-48 vdc



MINI KABELAANSLUITPUNT POWERPOSTJUNCTION MINI VERTEILUNGSPUNKT

nr.		vdc	amp
95805107	●	12-48	160 6
95805108	●	12-48	160 6
95805111	●	12-48	160 8
95805112	●	12-48	160 8
95805111/M	●	12-48	160 M8
95805112/M	●	12-48	160 M8
95805109	●	12-48	160 10
95805110	●	12-48	160 10



MAXI KABELAANSLUITPUNT POWERPOSTJUNCTION MAXI VERTEILUNGSPUNKT

nr.		vdc	amp
9587385	●	12-48	160 10
9587386	●	12-48	160 10
9587383	●	12-48	160 8
9587384	●	12-48	160 8
9587385/M	●	12-48	250 M10
9587386/M	●	12-48	250 M10



KABELAANSLUITPUNT MET ONDERVERDELING POWERPOSTJUNCTION WITH ROUND TERMINAL BOARD

VERTEILUNGSPUNKT MIT SAMMELSCHIENE 8 FACH 20A per contact 12-48V

nr.			
800778/r	●	160A	M8
800778/z	●	160A	M8



HD KABELAANSLUITPUNT M10 HD POWERPOSTJUNCTION HD VERTEILUNGSPUNKT

nr.		vdc	max vdc	eh
95877510M0N02	●	12-48	12V@250A	1
95877510M0N14	●	12-48	12V@250A	1



4 PUNTS COMPACTE STROOMRAIL/BUSBAR COMPACT BUSBAR TERMINAL 4 CONN. SAMMELSCHIENE KOMPAKT 4-FACH

Belasting max : 12 vdc @ 210 A

nr.	omschrijving	vdc	eh
95807704N0N02	1 x ¼ + 3 x ¾	12-48	1
95807704N0N14	1 x ¼ + 3 x ¾	12-48	1



VERDEELSTRIP MET AFDEKKAP ELECTRIC TERMINAL BOARD WITH COVER

SAMMELSCHIENE MIT SCHUTZKAPPE 15A per contact 20A piek

nr.		vdc
9587713	12-voudig	12-48 ●
9587712	12-voudig	12-48 ●



VERDEELSTRIP BUSBAR TERMINAL BOARD SAMMELSCHIENE

10-VOUDIG

15A per contact 20A piek 150A

nr.		vdc
9587723	12-48	10-voudig ●
9587722	12-48	10-voudig ●
9587723/K	12-48	kap / cap ●
9587722/K	12-48	kap / cap ●



VERDEELSTRIP MET AFDEKKAP HEAVY DUTY BUSBAR TERMINAL WITH COVER SAMMELSCHIENE

MIT SCHUTZKAPPE 250A

nr.		vdc
95874010/r	12-48	● 4 x M10
95874010/z	12-48	● 4x M10
95874008/r	12-48	● 4 x M8
95874008/z	12-48	● 4 x M8



VLAKSTEKKER STROOMRAIL FLATPLUG BUSBAR FLACHSTECK SAMMELSCHIENE

20A per connectie

nr.		vdc	max vdc	eh
9580710N02	●	12-48	12V@250A	1
9580710N14	●	12-48	12V@250A	1

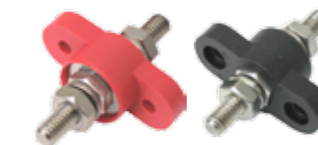

DOORVOER POWER POST JUNCTIONBOX DURCHFÜHRUNG

nr.		ISS
80077231/r	5/16	●
80077231/z	5/16	●
80077237/r	3/8	●
80077237/z	3/8	●



DOORVOER MET AFDEKKAP POWER POST JUNCTION-BOX WITH COVER DURCHFÜHRUNG MIT SCHUTZKAPPE

nr.		M
80037602W/r	10	●
80037602W/z	10	●

AFDEKKAPPEN - ISOLATING CAPS - ISCHUTZKAPPEN

ACCUPOOLKLEMMEN BLZ 34 - BATTERY TERMINALS PAGE 34 - BATTERIEPOLKLEMMEN SEITE 34



VOOR DRAADEIND
 FOR THREADED END
 FÜR GEWINDEENDE

nr.		vpe
800456/r	●	10
800456/z	●	10
800457/r	●	10
800457/z	●	10



NORMAAL (LAAG MODEL)
 NORMAL (LOW MODEL)
 NORMAL (NIEDRIGES MODELL)

nr.		vpe
800316/r	●	10
800316/z	●	10



VOOR MEERDERE KABELS (HOOG MODEL)
 FOR MULTIPLE CABLES (HIGH MODEL)
 FÜR MEHRERE KABEL (HOHES MODELL)

nr.		vpe
800314/r	●	10
800314/z	●	10



ENKEL / SINGLE / EINZEL

nr.		vpe
800454/r	●	10
800454/z	●	10



DUBBEL / DOUBLE / DOPPELT

nr.		vpe
800451/r	●	10
800451/z	●	10

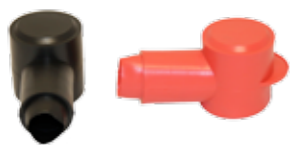

VOOR DYNAMO'S, LAADSTROOMVERDELERS EN STARTMOTOREN
verpakt per 10

nr.	mm	
800212N1/r	12	●
800212N1/z	12	●
800212N2/r	12	●
800212N2/z	12	●
800218/r	18	●
800218/z	18	●
800220/r	20	●
800220/z	20	●
800224/r	22	●
800224/z	22	●
800228/r	28	●
800228/z	28	●



VOOR 90° KABELSCHOENOGEN

nr.	mm ²	vpe
800962/r	10/16	10
800962/z	10/16	10
800963/r	25	10
800963/z	25	10
800964/r	35/50	10
800964/z	35/50	10
800966/r	70	10
800966/z	70	10
800967/r	95	10
800967/z	95	10
800968/r	120	10
800968/z	120	10

Andere maatvoering op aanvraag leverbaar



KAST V.Z.V. TRANSPARANTE DEKSEL

nr.	omschrijving	maten L x B x D
6722002	2 modules	135 x 76 x 102
6722004	4 modules	190 x 112 x 106
6722008	8 modules	190 x 184 x 106
6722012	12 modules	250 x 256 x 140
6733002	2 modules zonder deksel	130 x 52 x 60
6733004	4 modules met deksel	200 x 122 x 95
6733008	8 modules met deksel	200 x 184 x 95
6733012	12 modules met deksel	200 x 256 x 95
6733024	24 modules met deksel	330 x 268 x 95
6733036	36 modules met deksel	

DOORVERBINDRAIL/VERDEELKAMMEN

ALLEEN VOOR AUTOMATEN



nr.	omschrijving
99G2L1BG	set Doorverbindrail



nr.	omschrijving
5122908	2 phase 8 lengte 72 mm
5122910	2 phase 10 lengte 88 mm
5122924	2 phase 24 Lengte 220 mm



DINRAIL T.B.V. AUTOMATEN
 DINRAIL FOR CIRCUITBREAKER
 DIN TRAGSCHIENE FÜR LS

nr.	omschrijving
15-4604	Per meter



AARDLEKAUTOMAAT B-KARAKTERISTIEK
 MCB DOUBLE LEAKAGE PROTECTOR
 MCB FEHLERSTROM-/LEITUNGSSCHUTZSCHALTER

nr.	omschrijving
64621610	B10A,30mA, 1 P+N 6KA
64621630	B16A, 30mA, 1 P+N, 6KA
64621625	B25A,30mA, 1 P+N 6KA
64510016	18mm B16A, 30mA, 1 P+N, 6KA



AARDLEKSCHAKELAAR TYPE A
 RCBO LEAKAGE PROTECTOR
 RCBO FEHLERSTROM-/LEITUNGSSCHUTZSCHALTER

nr.	omschrijving
64624030	40 ampère, 2-polig, 30mA, 10KA



INSTALLATIE AUTOMAAT 1 POLIG+N,
 1 MODULE B-KARAKTERISTIEK 6KA (18MM)
 CIRCUITBREAKER SWITCH
 LEITUNGSSCHUTZSCHALTER 1-POLIG

nr.	omschrijving
644206	6 ampère
644210	10 ampère
644216	16 ampère
644220	20 ampère
644225	25 ampère
644232	32 ampère
644240	40 ampère



**INSTALLATIE AUTOMAAT 1 POLIG,
1 MODULE B-KARAKTERISTIEK 10KA
CIRCUITBREAKER
LEITUNGSSCHUTZSCHALTER**

nr.	ampère
641006	6
641010	10
641016	16
641020	20
641025	25
641032	32
641040	40
641050	50
641063	63

**NIET VOOR DC
NOT FOR DC
NICHT FÜR DC**



**AARDRAIL
EARTH RAIL
ERDUNGSSCHIENE**

nr.	lengte / length / Länge	max
15-4002	1 meter 56 M6	63A
15-4003	1 meter 40 M8	100A
15-4004	1 meter 30 M10	200A



**AUTOMATISCHE ZEKERING
CIRCUITBREAKER
SICHERUNGSAUTOMAT**

nr.	amp
6412080	80
6412100	100
6412160	150
6412180	180
6412200	200

RECOMMENDED CABLE AND FUSE BREAKER

Inverter	Cable size < 3 meter	Cable size > 3 meter	Fuse breaker
12v 1500w	50 mm ²	95 mm ²	180 Amp
24v 1500w	35 mm ²	50 mm ²	80 Amp
12v 2000w	70 mm ²	120 mm ²	200 Amp
24v 2000w	50 mm ²	70 mm ²	100 Amp
24v 3000w	70 mm ²	95 mm ²	160 Amp
48v 3000w	35 mm ²	50 mm ²	80 Amp

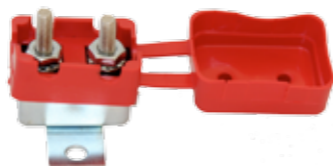

**AUTOMATISCHE ZEKERING
CIRCUITBREAKER
SICHERUNGSAUTOMAT**

nr.	omschrijving
960020	20A
960030	30A
960040	40A



**ACCULADER
BATTERY CHARGER
LADEGERÄT**

4 trapsacculader geschikt voor Natte-, Gel-, AGM- en LI Ion accu's. Ook geschikt als power supply.

4-stage battery charger suitable for lead batteries, gel batteries, AGM batteries and I-ION batteries. Also suitable as a power supply.

4-stufiges Batterieladegerät für Bleibatterien, Gelbatterien, AGM-Batterien und I-ION-Batterien. Auch als Stromversorgung geeignet.

nr.	
WSC1215	12vdc 15 A
WSC1230	2A 2x 30A



**SCHEIDINGSRELAIS AUTOMATISCHE HERKENNING
SEPARATORRELAY AUTOMATIC RECOGNITION
TRENNRELAIS AUTOMATISCHER ERKENNUNG**

nr.		max
DG-100SR	12/24	100A
DG-140SR	12/24	140A
DG-160SR	12/24	160A



**ACCULADER
BATTERY CHARGER
LADEGERÄT**

Acculader voor 3 accu's welke ook nog eens afzonderlijk zijn in te stellen, dus gelijktijdig bv. natte-gel-agm accu laden.

Battery charger for 3 batteries which can also be set separately so simultaneously charge lead-gel or agm battery.

Batterieladegerät für 3 Batterien, die auch separat eingestellt werden können, um gleichzeitig Blei-Gel- oder Agm-Batterie zu laden.

nr.	
OC1260	12 vdc
OC2430	24 vdc



**VERLIESVRIJE LAADSTROOMVERDELERS
BATTERY ISOLATOR
BATTERIEISOLATOR VERLUSTARMEN
VERTEILUNG**

Er zijn geen aanpassingen aan de dynamo nodig, ook niet voor dynamo's die herkenning nodig hebben.

nr.	accu output voor/for/zum	Dynamo/alternator Lichtmaschine max
DG100/2IG	2 accusets/batteries/Batterien	100A
DG100/3IG	3 accusets/batteries/Batterien	
DG150/2IG	2 accusets/batteries/Batterien	150A
DG150/3IG	3 accusets/batteries/Batterien	
DG200/3IG	3 accusets/batteries/Batterien	200A
met 2 ingang - with 2 input - mit 2 eingang		
DG2M100/3	geen herkenning no IG connection Ohne verlustarmen Verteilung	100A



**PVC- EN RUBBERPRODUCTEN
PVC AND RUBBER PRODUCTS
PVC- UND GUMMIPRODUKTE**



RUBBER PROFILES

DE EXPERT IN TPE RUBBERPROFIELEN
THE EXPERT IN CUSTOM MADE PROFILES
DER EXPERTE IN TPE GUMMIPROFIELEN

RUBBER PROFIELEN VAN TOPKWALITEIT
TOP QUALITY RUBBER PROFILES
GUMMIPROFILE IN HÖCHSTE QUALITÄT

+31 (0) 321 74 40 42
info@dgrubberprofiles.nl
www.dgrubberprofiles.nl

DG RUBBER PROFILES B.V.
Loofklapper 16a
8256 SL Biddinghuizen



RUBBER PROFILES

WAAROM TPE?
TPE is een synthetisch rubber die bij kamertemperatuur elastische druk- en trekkracht kan weerstaan.
Daarnaast heeft TPE een lange levensduur en is goed bestendig tegen UV-licht, zout water en temperatuurverschillen.
TPE is in verhouding tot andere polymeren goed te bewerken en heeft daarom relatief voordelige matrijkskosten.

WAAROM DG RUBBER PROFILES?
Door onze ervaring met TPE extrusie kunnen wij bijna elke mogelijke vorm als profiel produceren en kunnen wij snel en goedkoop leveren. Wij kunnen ons rubber in alle mogelijke RAL kleuren leveren en in 4 verschillende hardheden.

WHY CHOOSE TPE?
TPE is a synthetic rubber that can withstand elastic push and pull forces at room temperature.
In addition TPE has also a longer lifespan and is well resistant to UV light, salt water and temperature differences.
Compared to other polymers, TPE is easy to process and therefore has a relative low mold cost.

WHY CHOOSE DG RUBBER PROFILES?
DG Rubber Profiles had a lot of experience in TPE extrusion. There are four hardnesses to choose from.
We are able to produce almost all shapes and RAL Colours. And last not least a fast delivery!

WARUM TPE?
TPE ist ein synthetisches Gummi, das bei Raumtemperatur elastischen Druck- und Zugkräften standhalten kann.
Ausserdem hat TPE eine lange Lebensdauer und eine gute Beständigkeit gegen UV-Licht, Salzwasser und Temperaturunterschiede. TPE ist im Vergleich zu anderen Polymeren einfach zu verarbeiten und hat daher relativ günstige.

WARUM DG RUBBER PROFILES?
DR Rubber Profiles hat sehr viel Erfahrung mit der TPE-Extrusion. Es stehen vier Härtegrade zur Auswahl.
Wir können nahezu alle Formen und RAL-Farben herstellen. Und schließlich können wir schnell und günstig liefern.



KIJK OP ONZE WEBSITE VOOR MEER INFORMATIE OVER NIEUWE PRODUCTEN EN DOWNLOAD TECHNISCHE DATASHEET



**RAAMRUBBER
SEALING WINDOW PROFILE
FENSTERKLEMMPROFIL**

Tollerantie: ISO 3302-1 E2
3/4

nr.	rollengte / role / Rolle
2015165/G ● TPE	25 meter

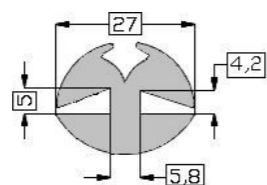

**RAAMRUBBER
SEALING WINDOW PROFILE
FENSTERKLEMMPROFIL**

Tollerantie: ISO 3302-1 E2
4/5

nr.	rollengte / role / Rolle
2014074/G ● TPE	25 meter

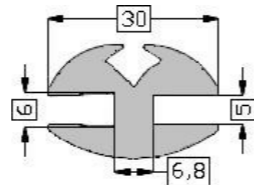

**RAAMRUBBER
SEALING WINDOW PROFILE
FENSTERKLEMMPROFIL**

Tollerantie: ISO 3302-1 E2
5/6

nr.	rollengte / role / Rolle
20181267/G ● TPE	25 meter

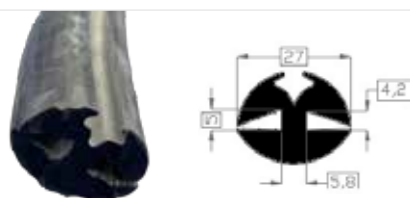

**RAAMRUBBER
SEALING WINDOW PROFILE
FENSTERKLEMMPROFIL**

Tollerantie: ISO 3302-1 E2
4/5

nr.	rollengte / role / Rolle
102745 ● EPDM Talk	25 meter
102745-ES ● EPDM Vet	25 meter
2014074/Z ● TPE	25 meter

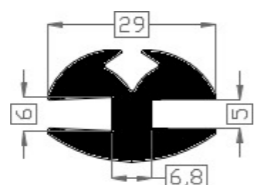

**RAAMRUBBER
SEALING WINDOW PROFILE
FENSTERKLEMMPROFIL**

Tollerantie: ISO 3302-1 E2
5/6

nr.	rollengte / role / Rolle
1000056 ● EPDM	25 meter
20181267/Z ● TPE	25 meter



**RAAMRUBBER
SEALING WINDOW PROFILE
FENSTERKLEMMPROFIL**

Tollerantie: ISO 3302-1 E2
7,5/4,7

nr.	rollengte / role / Rolle
2014035 ● TPE	25 meter

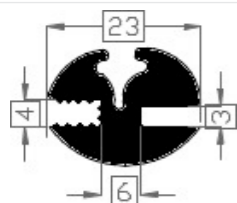

**RAAMRUBBER
SEALING WINDOW PROFILES
FENSTERKLEMMPROFIL**

Tollerantie: ISO 3302-1 E2
3/4

nr.	rollengte / role / Rolle
1000034 ● EPDM	25 meter
20223025/Z ● TPE	25 meter

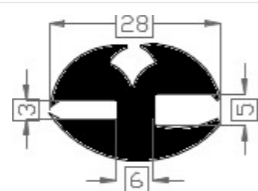

**RAAMRUBBER
SEALING WINDOW PROFILE
FENSTERKLEMMPROFIL**

Tollerantie: ISO 3302-1 E2
3/5

nr.	rollengte / role / Rolle
1000053 ● EPDM	25 meter
20222986/Z ● TPE	25 meter

**RUBBER
PROFILES**



**PEES- SPIERTREKKER
PROFILE PULLER
EINZIEHWERKZEUG FÜR FÜLLERPROFILE**

nr.	
1000018	Pees- spiertrekker t.b.v. raamrubbers



**VULBIES
FILLER STRIP
FÜLLROHR**

Profiel voor het afdekken van schroefjes in aluminiumramen.

nr.	mm	rollengte / role / Rolle
1000011 zwart	13 PVC	100 meter
1000012 zilver	13 PVC	100 meter
	metalic	
20212768/Z zwart	13 TPE	100 meter
20212768/G grijs	13 TPE	100 meter

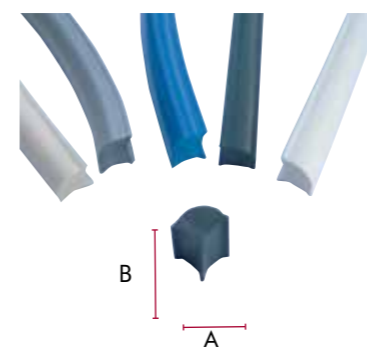

**PVC PEES T.B.V. RAAMRUBBERS
TENDON FOR WINDOW SEALS
FÜLLER FÜR FENSTERKLEMMPROFILE**

STANDAARD - STANDARD - STANDARD

GROOT - LARGE - GROSS

maten	rollengte / role / Rolle
A: 8 mm	50 meter
B: 9 mm	

maten	rollengte / role / Rolle
A: 9 mm	50 meter
B: 10 mm	

nr.		
1000006 ○	PVC	
1000007 ●	PVC	
1000008 ●	PVC	
1000009 ●	PVC	
1000010 ●	PVC	

1000071 ●	PVC
1000081 ●	PVC
1000091 ●	PVC
20233263/z ●	TPE
20233263/c ●	TPE
20233263/g ●	TPE

20212778/W ○	TPE
20212778/Z ●	TPE
20212778/C ●	TPE
20212778/G ●	TPE
20212778/B ●	TPE

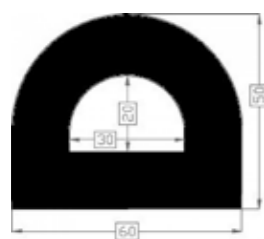

TPE STOOTRAND
TPE FENDER
TPE SCHEUERLEISTE

D-profiel, 60 x 60 mm

nr.	rollengte / role / Rolle
2014020	25 meter

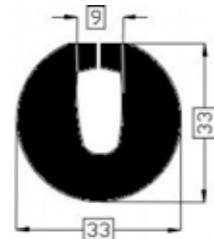

TPE STOOTRAND
TPE FENDER
TPE SCHEUERLEISTE

O-profiel, Ø 30 mm

nr.	rollengte / role / Rolle
2014022	25 meter

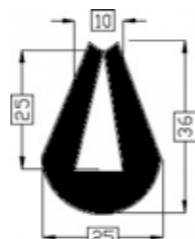

TPE STOOTRAND
TPE FENDER
TPE SCHEUERLEISTE

U-profiel, 36 x 25 mm

nr.	rollengte / role / Rolle
2014004	25 meter

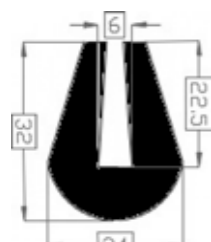

TPE STOOTRAND
TPE FENDER
TPE SCHEUERLEISTE

U-profiel, 32 x 24 mm

nr.	rollengte / role / Rolle
2014042	25 meter

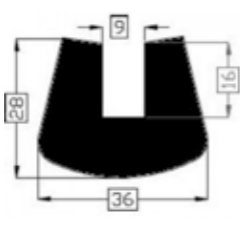

TPE STOOTRAND
TPE FENDER
TPE SCHEUERLEISTE

U-profiel, 36 x 36 mm

nr.	rollengte / role / Rolle
2014003	25 meter

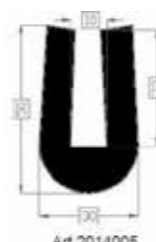

TPE STOOTRAND
TPE FENDER
TPE SCHEUERLEISTE

U-profiel, 46 x 30 mm

nr.	rollengte / role / Rolle
2014005	● TPE 25 meter

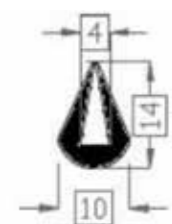

TPE STOOTRAND
TPE FENDER
TPE SCHEUERLEISTE

U-profiel, 14 x 10 mm

nr.	rollengte / role / Rolle
2014055	25 meter

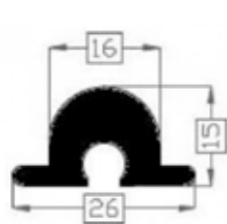

TPE INSCHUIFFENDER
TPE FENDER INSERT
TPE SCHEUERLEISTE

28 x 15 mm

nr.	rollengte / role / Rolle
2014033/70	25 meter

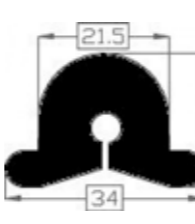

TPE INSCHUIFFENDER
TPE FENDER INSERT
TPE SCHEUERLEISTE

34 x 22 mm

nr.	rollengte / role / Rolle
2014015/70	25 meter



TPE KABELARING STEUN-RAND
TPE PROFILE FOR HAND KNITTED FENDER
TPE PROFIL FÜR GEKNÜPFTE FENDER

Enkel, 50 x 36 mm

nr.	rollengte / role / rolle
2014037/70	25 meter

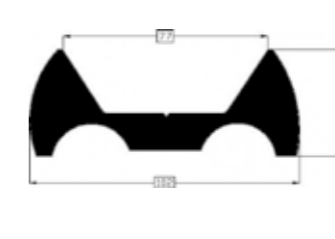

TPE KABELARING STEUN-RAND
TPE PROFILE FOR HAND KNITTED FENDER
TPE PROFIL FÜR GEKNÜPFTE FENDER

Dubbel, 102 x 40 mm

nr.	rollengte / role / rolle
2014067/70	25 meter



POSEIDON MARINE KIT

Langzaam drogende kit. Zeer geschikt voor TPE profielen.

nr.	vpe
8844468	per stuk of doos van 12 per piece or box of 12 pro Stück oder Karton mit 12 Stück



DUBBELZIJDIGE TAPE
DOUBLE SIDED TAPE
DOPPELSEITIGES KLEB-BAND

Uitermate geschikt voor TPE profielen
Extremely suitable for TPE profiles
Sehr gut geeignet für TPE Profile

nr.	rollengte / role / rolle
85553	3 meter



DG POWER CONSTRUCTIELIJM
DG POWER CONSTRUCTION-GLUE
DG POWER KLEBSTOFF

Snelhardend en waterbestendig
Quick drying and water resistant
Schnellhärtend und wasserdicht

nr.	rollengte / role / rolle
DKIT	



DG SUPER LIJM
DG SUPER GLUE
DG SUPER KLEBER

Universele krachtige secundelijm
Quick drying and water resistant
Schnellhärtend und wasserdicht

nr.	rollengte / role / rolle
DGLIJM	

RUBBER
PROFILES



SPONSRUBBER D-PROFIEL
NEOPRANE D
MOOSGUMMI D-PROFIL
 ZELFKLEVEND - SELF-ADHESIVE -
 SELBSTKLEBEND

nr.	afm.	rollengte/role/Rolle
75801412	14 x 12	100 meter
75801210	12 x 10	100 meter
75802217	21 x 17	50 meter
7580806	8 x 6	50 meter



SPONSRUBBER RECHTHOEK
NEOPRANE FOAM SEAL
MOOSGUMMI RECHTECK

EPDM met rondom een huid, gesloten cel, 15 shoreA

nr.	afmeting	rollengte
7541503	15 x 3	100 meter
7542003	20 x 3	100 meter
7542503	25 x 3	50 meter
7541005	10 x 5	50 meter
7541505	15 x 5	50 meter
7542005	20 x 5	50 meter
7542505	25 x 5	50 meter
7543005	30 x 5	50 meter
7545005	50 x 5	25 meter
7541510	15 x 10	50 meter
7542010	20 x 10	50 meter
7542510	25 x 10	50 meter
7543010	30 x 10	25 meter
7544010	40 x 10	25 meter
7542015	20 x 15	25 meter
7542515	25 x 15	25 meter
7543015	30 x 15	25 meter
7543515	35 x 15	25 meter
7544015	40 x 15	25 meter
7543020	30 x 20	25 meter
7544020	40 x 20	25 meter
7543025	30 x 25	25 meter
7544030	40 x 30	25 meter



KROONBAND
SEALING PROFILE
KRONENPROFIL

MET KLEEFLAAG - SELF-ADHESIVE -
 SELBSTKLEBEND

nr.	afm.	rollengte
75801508	15 x 8	50 meter



SPONSRUBBER ROND
NEOPRANE ROUND
MOOSGUMMI RUND

EPDM met rondom een huid, Gesloten cel, 15 shoreA

nr.	diameter	rollengte
7540006	Ø 6	100 meter
7540008	Ø 8	100 meter
7540010	Ø 10	50 meter
7540012	Ø 12	50 meter
7540015	Ø 15	50 meter
7540025	Ø 25	25 meter
7540030	Ø 30	25 meter



SPONSRUBBER V-PROFIEL
NEOPRANE V-PROFILE
MOOSGUMMI V-PROFIL

nr.	afm.	rollengte
7580555	16 x 15 mm	50 meter



ZELFKLEVEND L-PROFIEL
SELF-ADHESIVE L-PROFILE
L-PROFIL SELBSTKLEBEND

nr.	afm.	rollengte
7592019	20 x 19 mm	50 meter
7591615	16 x 15 mm	50 meter



SPONSRUBBER VIERKANT
NEOPRANE SQUARE
MOOSGUMMI QUADRAT

EPDM met rondom een huid, Gesloten cel, 15 shoreA

nr.	maat	rollengte
7540606	6 x 6	100 meter
7540808	8 x 8	100 meter
7541010	10 x 10	50 meter
7541212	12 x 12	50 meter
7541515	15 x 15	50 meter

CEL RUBBER STRIP **SELFADHESIVE RUBBER PROFILE**
ZELLGUMMI SELBSTKLEBEND

EPDM, éénzijdig zelfklevend. Gesloten cel.

nr.	breedte mm	dikte mm	rollengte / role / rolle
7500902	9	2	200 meter
7501002	10	2	200 meter
7501502	15	2	160 meter
7502002	20	2	100 meter
7503002	30	2	60 meter

7501003	10	3	160 meter
7501503	15	3	100 meter
7502003	20	3	60 meter
7502503	25	3	60 meter
7503003	30	3	40 meter
7503503	35	3	20 meter
7504003	40	3	20 meter

7501005	10	5	100 meter
7501505	15	5	60 meter
7502005	20	5	40 meter
7502505	25	5	40 meter
7503005	30	5	30 meter
7504005	40	5	20 meter
7504505	45	5	20 meter

7501006	10	6	80 meter
7501506	15	6	40 meter
7502006	20	6	40 meter
7502506	25	6	30 meter
7503006	30	6	20 meter
7503506	35	6	10 meter

7501010	10	10	50 meter
7501510	15	10	30 meter
7502010	20	10	20 meter
7502510	25	10	10 meter
7503010	30	10	10 meter
7503510	35	10	10 meter
7504010	40	10	10 meter

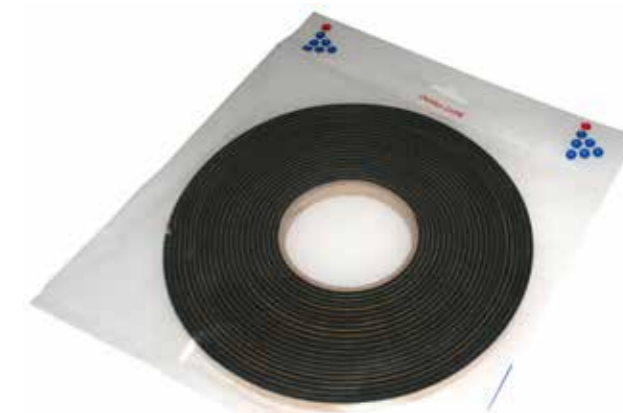

7502015	20	15	10 meter
7502020	20	20	10 meter
7502520	25	20	10 meter
7504020	40	20	10 meter
7505020	50	20	10 meter



nr.	breedte mm	dikte mm	rollengte / role / rolle
7501003/10	10	3	10 meter
7501503/10	15	3	10 meter
7502003/10	20	3	10 meter
7502503/10	25	3	10 meter
7503003/10	30	3	10 meter
7501005/10	10	5	10 meter
7501505/10	15	5	10 meter
7502005/10	20	5	10 meter
7502505/10	25	5	10 meter
7503005/10	30	5	10 meter

 RUBBERVLOERBEDEKKING  RUBBER FLOORCOVER  GUMMIBODENBELAG



 **FIJN GERIBD**
TREEPLANKRUBBER
 **FINE RIBBED RUNG RUBBER**
 **FEINTRIEFEN TRITTBRETT-**
GUMMI

nr.	dikte mm	rolafmeting
7300000	3 ●	1,2m x 10m
7300000.1	3 ●	1,0m x 10m

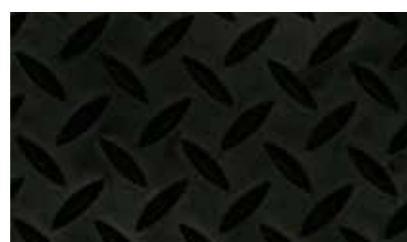

 **TRAANPLAATMOTIEF**
 **CHECKER PLATE**
 **RIFFELBLECH**

nr.	dikte mm	rolafmeting
7312000	3mm	1,5m x 10m
7312001	3mm	1,4m x 10m

oliebestendig /
oil resistant / Ölbeständig



 **NOPPENMOTIEF**
 **COIN GRIP PATTERN**
 **FLACHNOPPEN STRUKTUR**

nr.	dikte mm	rolafmeting
7311247	3 ●	1,2m x 10m



 **RINGMATTEN**
 **RINGMATS**
 **RINGGUMMIMATTE**

nr.	afmeting
7313004	● 100 x 75 cm
7313005	● 150 x 100 cm



 **VERBINDINGSSTUKKEN**
 **CONNECTORS**
 **VERBINDER**
(VOOR ONZE RINGMATTEN - FOR OUR
RINGMATS - FÜR UNSERE RINGMATTEN)

nr.	afmeting
7313333	



 **RIJSTKORREL PROFIEL**
 **GRAIN OF RICE PROFILE**
 **REISKORN STRUKTUR**

Profiel 3mm dik



nr.	dikte mm	rolafmeting
7300005	3 ●	1,5m x 10m



 **KLEIN DIAMANT PROFIEL**
 **SMALL DIAMOND PROFILE**
 **KLEINES DIAMANT PROFIL**

nr.	maat
7312002	1,2 mtr x 10 mtr ●





 **ANTISLIPMAT TYPE SAFE**
 **NON-SLIP MAT AQUA-SAFE**
 **RUTSCHFESTE MATTE**
TYP AQUA-SAFE
ZELFKLEVEND - SELF-ADHESIVE -
SELBSTKLEBEND

nr.	afmeting
71119010	● 119x1000 cm



 **ANTISLIP TAPE** 
 **ANTI RUTSCH-KLEBEBAND**

GLOW LINE
 Niet giftig en vrij van fosfor of
radioactief materiaal.
 Non-toxic and free of phosphorus or
radioactive material.
 Ungiftig und frei von Phosphor oder
radioaktivem Material.

nr.	rolafmeting
71119110	Glow 50mm x 18 meter
71119112	Zwart 50mm x 18 meter



 **PAKKINGSPLAAT SBR**
 **GASKETPLAT SBR**
 **DICHTUNGSPLATTE SBR**

Beide zijden glad / smooth / glatt
1,4 meter breed

nr.	dikte mm
7314001	 diverse diktes met en zonder inlage op aanvraag ●  various thickness with and without insert on request  verschiedene Dicken mit und ohne Einsatz auf Anfrage
7315103	met 1 inlage 3mm



NEO BENZID

 **OLIE, BENZINE EN BIO-DIESEL BESTENDIG PAKKINGSPLAAT**
 **OIL-GASOLINE AND BIO DIESEL RESISTANT GASKETPLATE**
 **ÖL, BENZIN UND BIODIESEL BESTÄNDIGE DICHTUNGSPLATTE**

nr.	dikte mm	rolafmeting
7316003	3 ●	1,4m x 10m
7316005	5 ●	1,4m x 10m



 **ANTISLIPMAT ZELFKLEVEND**
TRAANPLAAT MOTIEF MET AFGERONDE HOEKEN
 **NON-SLIP MAT SELF ADHESIVE**
 **ANTIRUTSCHMATTE SELBSTKLEBEND**

nr.	afmeting
73332801.1	450 x 450 mm
73332802.1	150 x 450 mm
73332803.1	200 x 500 mm
73332804.1	200 x 650 mm
73332806.1	340 x 660 mm
73332807.1	160 x 600 mm
73332808.1	710 x 490 mm

 **PRIJZEN PER M²**
 **PRICES PER M²**
 **PREISE PRO M²**

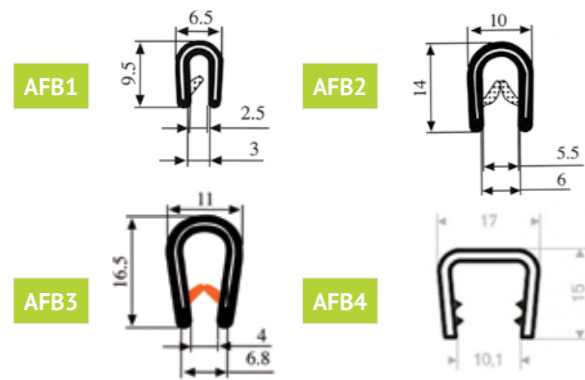

ZELFKLEMMEND U-PROFIEL KLEIN
CLAMPING U-PROFILE
SELBSTHEMMEDES U-PROFIL

nr.	klembereik		AFB	rollengte
2001013	1 - 3 mm	●	1	50 meter
2005025	2 - 5 mm	●	2	50 meter
2005125	2 - 5 mm	●	2	50 meter
2005068	6 - 8 mm	●	3	50 meter
2005012	10 - 12 mm	●	4	50 meter

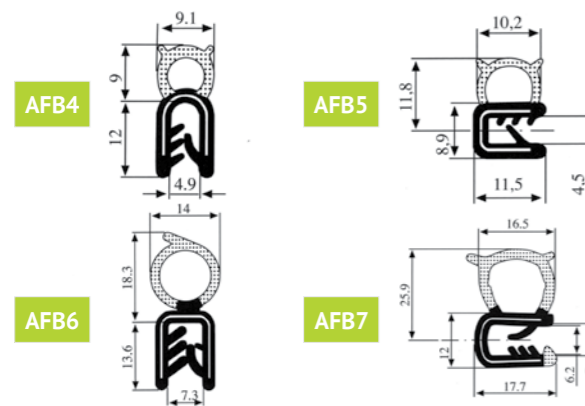

ZELFKLEMMEND U-PROFIEL
MET SPONS RUBBER
WITH WATERPROOF NEOPRENE FOAM SEAL
SELBSTHEMMEDES U-PROFIL MIT NEO-
PREN DICHTUNG

nr.	positie	klembereik	AFB	rollengte
2119013	bovenkant	1 - 3 mm	●	100 meter
2118013	zijkant	1 - 3 mm	●	100 meter
2009025	bovenkant	2 - 5 mm	●	50 meter
2008025	zijkant	2 - 5 mm	●	50 meter

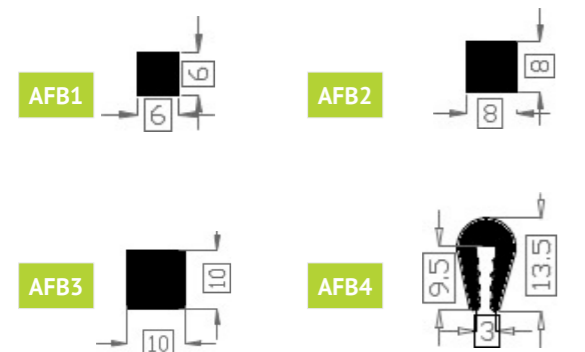

TPE PAKKING T.B.V. PATRIJSPOORTEN
SEAL FOR PORTHOLE
ABDICHTUNGSGUMMI FÜR BULLAUGEN

nr.	maten		AFB	rollengte
1050606	6 x 6 mm	●	1	50 meter
2014011	8 x 8 mm	●	2	50 meter
2014012	10 x 10 mm	●	3	50 meter

73261209	Volrubber 1 - 3 mm	●	4	50 meter
	Profil designed for trimming			
	Profilleiste			



GELUIDSISOLATIEPLAAT
SOUNDISOLATIONBOARD
SCHALLSCHUTZPLATTE

nr.	
9500020	2 x 1 x 0,3 cm
9500021	1,5 x 1 x 0,3 cm
9500022	1,5 x 1 x 0,5 cm
9500024	1,5 x 1,05 x 0,25 cm ●
9500025	1,5 x 1,05 x 0,25 cm ○



WATERZAK 20 LITER
POTABLE WATERBAG
TRINKWASSERSACK

nr.	omschrijving
155520	Oprolbaar, als rugzak te dragen can be rolled up, can be worn as a backpack Aufrollbar, kann als Rucksack getragen werden



O-RING BOX
METRISCH - METRIC - METRISCH

O-Ring box H NBR 70 Shore

nr.	
40917	30 maten / sizes / Grössen 404 stuks / pieces / Stück



STROOMLIJNFLAP
STREAMLINE RUBBER
GUMMI ABDECKPLATTE

nr.
DGR-117



BRANDSTOFZAK 20 LITER
FUEL BAG EASY TO CARRY
KRAFTSTOFFBEUTEL

nr.	omschrijving
155521	Oprolbaar, als rugzak te dragen can be rolled up, can be worn as a backpack Aufrollbar, kann als Rucksack getragen werden



O-RING BOX
INCH - INCH - ZOLL

O-Ring box G NBR 70 Shore

nr.	
34823	30 maten / sizes / Grössen 382 stuks / pieces / Stück



nr.			
DGR-01	A	Rubber bocht groot Rubber bend large Gummibiegung gross	
DGR-02	B	3-weg vormstuk 3 way molding 3-Wege Formteil	
DGR-03	C	Thermostaat bocht Thermostat bend Thermostatbiegung	



RONDSNOER SERVICE KIT
ROUND CORD SERVICE KIT
RUNDKABEL SERVICE KIT

Maak u eigen afdichtingsring
Make your own o-ring
Fertigen Sie Ihren eigenen O-Ring

nr.	
57248	1,8 tot/upto/bis 8mm lengtes/lengths/Länge 2m



DEMONTAGE SET 4-DELIG
DISASSEMBLY SET 4 PCS
DEMONTAGESATZ 4 STK

Demontage set voor o-ringen + u manchetten

nr.
502438

STOOTRANDEN - RUB RAIL - SCHEUERLEISTE



De radial PVC stootranden zijn de nieuwe ontwikkeling op (kunststof/PVC) stootranden gebied. Deze PVC stootrand hoeft niet meer verwarmt te worden in een bak warm water, maar kan koud worden gemonteerd nadat de basislijst op het te beschermen object (boot) is bevestigd.

Invisible rigid base designed to be placed on the hull, the external profile with easy pressure installation.

Unsichtbare starre Schiene, die mit dem Boot verschraubt wird. Die Scheuerleiste wird einfach durch andrücken darauf montiert.

TECHNISCHE TEKENINGEN RADIAL

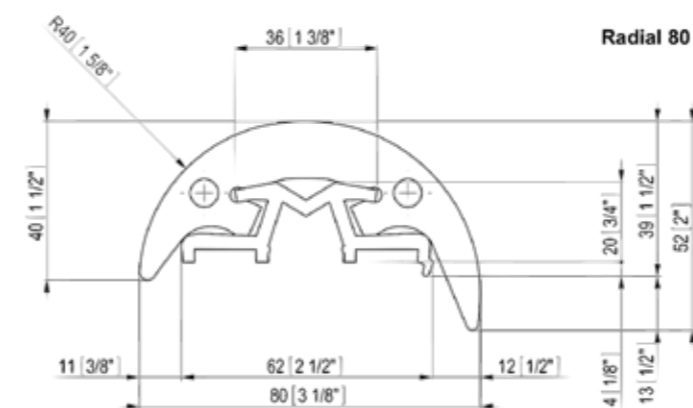
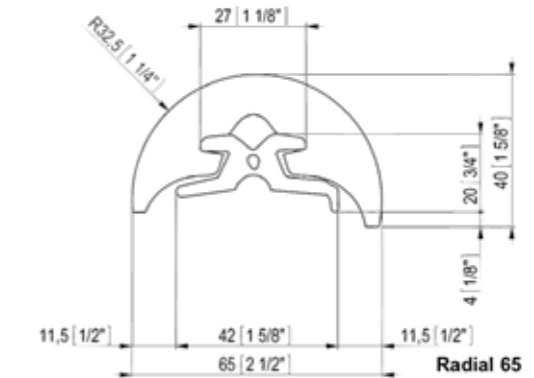
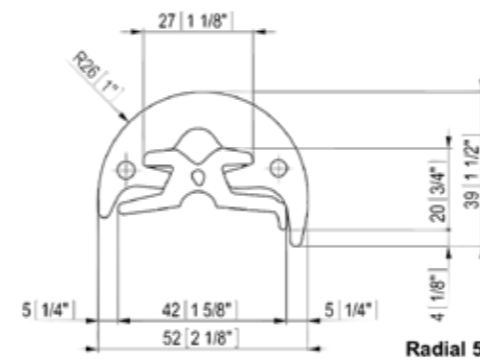
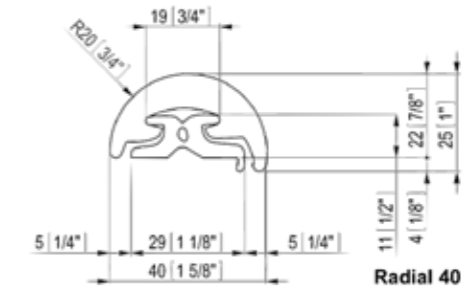
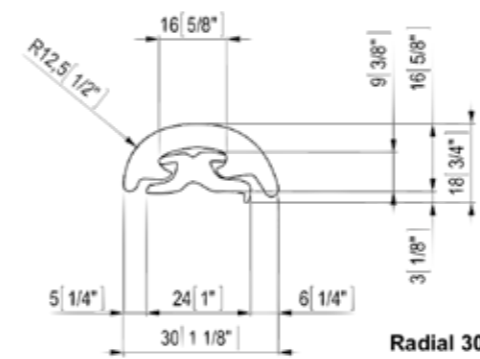

**PVC STOOTRANDEN INCLUSIEF ONDERLIJST
RUB RAIL DELIVERED COMPLETE
SCHEUERLEISTE KOMPLETT**

nr.	maten	gewicht g/m	rollengte
13014005	Radial 30 mm	541	24 meter
13014010	Radial 40 mm	855	24 meter
13014015	Radial 52 mm	1550	24 meter
13014020	Radial 65 mm	1610	24 meter
13014025	Radial 80 mm	1915	24 meter

Op verzoek leverbaar in afwijkende rollengte, maar altijd gebaseerd op 2 meter onderlijst

**RVS EINDKAPPEN
END CAP STAINLESS STEEL
ENDSTÜCK EDELSTAHL**

nr.	voor / for / für	
13114009	radial 30 mm	per stuk
13114011	radial 40 mm	per stuk
13114015	radial 52 mm	per stuk
13114022	radial 65 mm	per stuk

BINO



KLEUR / COLOR / FARBE:



- BINO STOOTRAND
- BINO FENDER PROFILE
- BINO SCHEUERLEISTE

nr.	maten	rollengte
130-115-001	Bino stootrand 40 x 23	24 meter
130-115-005	Bino stootrand 65 x 37	24 meter
130-115-010	Bino stootrand 90 x 53	24 meter

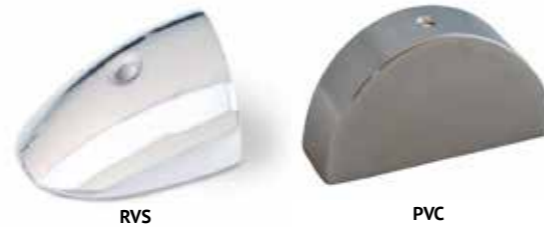

- EINDKAP BINO
- END CAP BINO
- ENDSTÜCK EDELSTAHL

nr.		mm
130-115-011	RVS	90
130-115-002	RVS	40
130-115-006	RVS	65
130-500-092/z	PVC	65
130-500-095/z	PVC	90

Afwijkende modellen op aanvraag.
 Different models on request.
 Andere Modelle auf Anfrage.

TECHNISCHE TEKENINGEN BINO

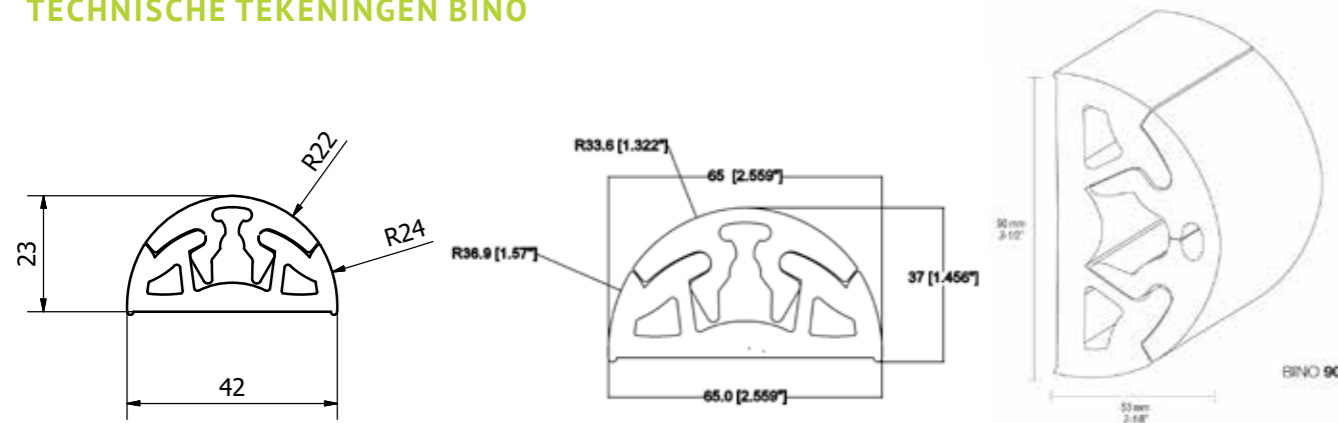

BINOX



- BINOX STOOTRAND BASIS
- BINOX FENDER PROFILE BASE
- BINOX SCHEUERLEISTE BASIS

nr.		vpe
130-230-040	BinoX 25mm ● ○	24 mtr
130-230-050	BinoX 35 mm ● ○	24 mtr
130-230-070	BinoX 50 mm ● ○	24 mtr
130-230-090	BinoX 65 mm ● ○	24 mtr



- BINOX INSERT RVS
- BINOX S/S BAR
- BINOX EINLAGE EDELSTAHL

nr.		vpe
130-230-125	BinoX 25 mm	24 mtr
130-230-135	BinoX 35 mm	24 mtr
130-230-150	BinoX 50 mm	24 mtr
130-230-165	BinoX 65 mm	24 mtr



- RVS EINDKAP BINOX
- STAINLESS STEEL ENDPiece BINOX
- ENDSTÜCK EDELSTAHL BINOX

nr.	
130-500-425	tbv BinoX 25 mm (set)
130-500-435	tbv BinoX 35 mm (set)
130-500-450	tbv BinoX 50 mm (set)
130-500-465	tbv BinoX 65 mm (set)



Projected and designed
by Tessimare - ITALY



RVS STRIP
S/S FENDER PROFILE INSERT
EINLAGE EDELSTAHL

nr.	maten	gewicht	lengte
130-130-125	25mm	470 g/m	3 meter
130-130-135	35mm	830 g/m	3 meter
130-130-150	50mm	1200 g/m	3 meter
130-130-165	65mm	1535 g/m	3 meter



BASE SLIM

nr.	gewicht g/m	voor sphaera		lengte rol
130-130-039/Z	125	25	●	24 meter
130-130-039/W	125	25	○	24 meter
130-130-049/Z	135	35	●	24 meter
130-130-049/W	135	35	○	24 meter
130-130-069/Z	183	50	●	24 meter
130-130-069/W	183	50	○	24 meter
130-130-089/Z	425	65	●	24 meter
130-130-089/W	425	65	○	24 meter

PVC ONDERLIJST
PVC BASE
BASIS FÜR PVC SCHEUERLEISTE



Rollengte 24 meter, kleur: wit

nr.	maten	rollengte	lengte
130-130-041	25mm	356 g/m	24 meter
130-130-051	35mm	646 g/m	24 meter
130-130-071	50mm	1400 g/m	24 meter
130-130-091	65mm	1635 g/m	24 meter

TECHNISCHE TEKENINGEN

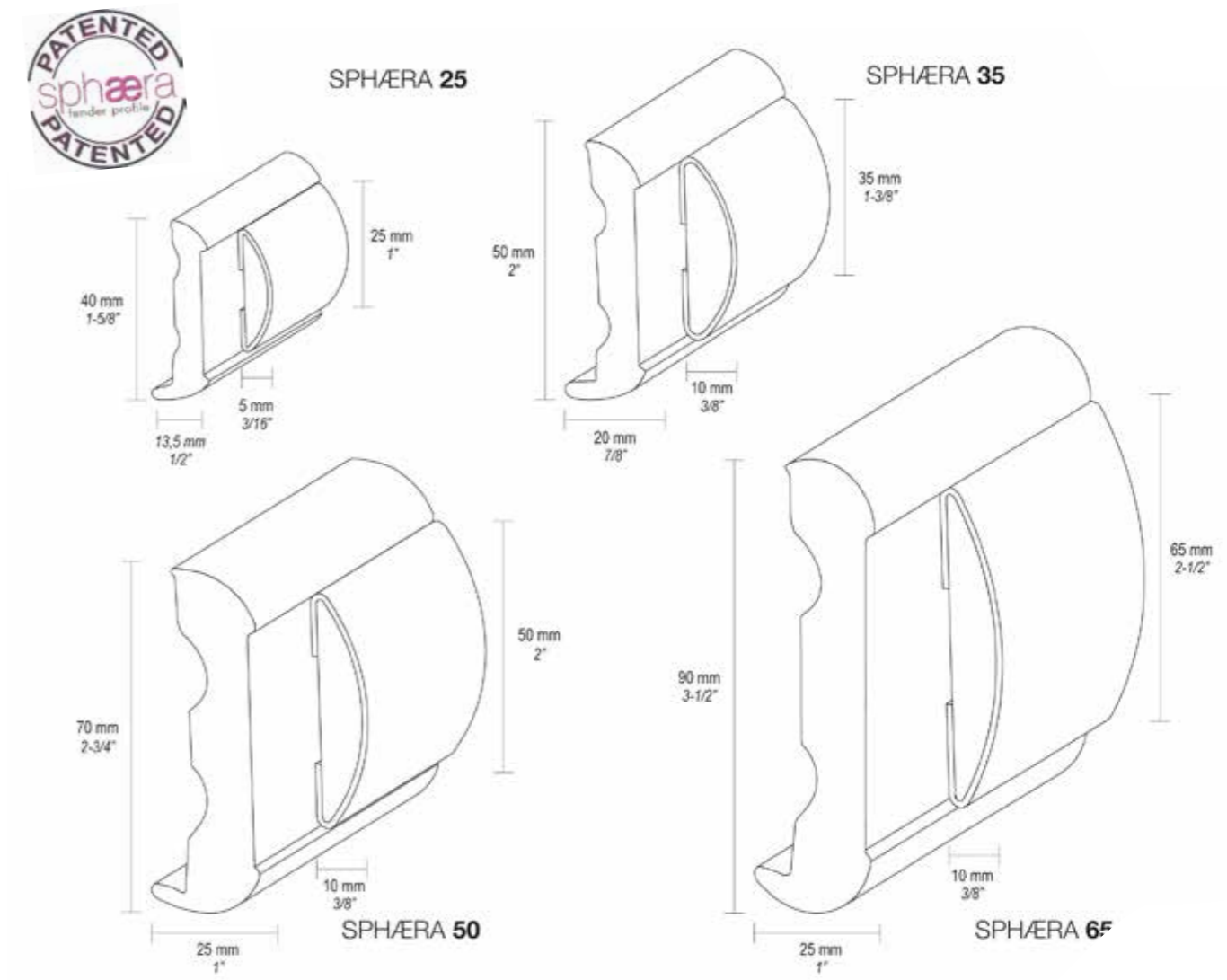

EINDKAP BASE SLIM
END CAP
ENDSTÜCK

nr.	maten	eenheid
130-500-625	25mm	per stuk
130-500-635	35mm	per stuk
130-500-650	50mm	per stuk
130-500-665	65mm	per stuk

DOORVERBINDEN
CONNECTOR
MITTELSTÜCK

Ook voor Binox

nr.	maten	eenheid
130-500-125	25mm	per stuk
130-500-135	35mm	per stuk
130-500-150	50mm	per stuk
130-500-165	65mm	per stuk

EINDKAP PVC BASE
END CAP
ENDSTÜCK

nr.	maten	eenheid
130-500-725	25mm	2 stuks
130-500-735	35mm	2 stuks
130-500-750	50mm	2 stuks
130-500-765	65mm	2 stuks



**SLANGEN
HOSES
SCHLAUCHEN**



**DIESELUITLAATSLANG
IN DE GEGOLFDE UITVOERING
HOSE FOR EXHAUSTSYSTEM
AUSPUFFSCHLAUCH MIT LLOYD'SABNAHME**

Rubber diesel uitlaatslang met stalen spiraal.
Voor watergekoelde dieselmotoren.

Temp.bereik: -30 °C tot +100 °C

Soepel, dus makkelijk te monteren LLOYDS en RINA gekeurd volgens Iso 13363 Certificaten zijn op aanvraag leverbaar
Let op: 5 jaar garantie!

Rubber diesel exhaust hose with steel spiral for water-cooled diesel engines.

Temp. range: -30 °C to +100 °C.

Flexible, resistant to oil-products, salt water and climate influences, LLOYD'S and RINA approved

according to ISO 13363. Certificates available on request.

5 year warranty

Diesel-Abgasschlauch aus Gummi mit einer Stahlspiraleinlage für wassergekühlte Dieselmotoren.

Temperaturbereich: -30 °C bis +100 °C.

Flexibel, beständig gegen Ölprodukte, Salzwasser und Klimaeinflüsse, von LLOYD'S und RINA zugelassen nach ISO 13363. Zertifikate auf Anfrage erhältlich.

Garantie: 5 Jahre

nr.	Ø / Q	rollengte / role / Rolle
3735020	20/28	20
3735025	25/33	20
3735032	32/40	20
3735038	38/46	20
3735040	40/49	20
3735045	45/54	20
3735051	51/60	20
3735060	60/70	20
3735065	65/74	20
3735076	76/86	20
3735080	80/90	20
3735090	90/100	20
3735102	102/113	20
3735110	110/121	20
3735127	127/137	20
3735150	150/163	20
3735203	203/219	10
3735305	305/325	op aanvraag / on request auf Anfrage



**BRANDSTOFSLANG ISO 7840 A1
FUEL HOSE SYNTHETIC RUBBER WITH
TEXTILE REINFORCEMENT
TREIBSTOFFSCHLAUCH MIT TEXTILER
STAHLSPIRALEINLAGE**

Gladde uitvoering CE gekeurd
Temp.bereik: -20°C tot +80°C



nr.	Ø / Q	werkdruk bar working pressure Arbeitsdruck	rollengte/role/Rolle
3330006	6/16	3	40
3330008	8/17	3	40
3330010	10/19	3	40
3330125	12,5/22	3	40
3330016	16/26	3	40
3330019	19/30	3	40
3330025	25/35	3	40



**BRANDSTOFSLANG ISO 7840 A1
FUELHOSE WITH METALSPIRAL
TREIBSTOFFSCHLAUCH MIT EINER
STAHLSPIRALEINLAGE**

Met doekafdruk en Stalen spiraal CE gekeurd
Temp.bereik: -20°C tot +80°C



nr.	Ø / Q	werkdruk bar working pressure Arbeitsdruck	rollengte/role/Rolle
3330032	32/42	3	20
3330038	38/48	3	20
3330050	51/61	3	20



BLADZIJDE / PAGE / SEITE 84

100 R4 SAE J 517

**OLIE EN KOELWATERSLANG
OIL AND COOLING WATER HOSE
ÖL- UND KÜHLWASSERSCHLAUCH**

Olie- en benzine bestendige zuigpersslang met stalen spiraal en "static-wire". Te gebruiken als vulslang of koelwaterslang.

Zeer soepele uitvoering.

Oil- and petrolresistant (suction/discharge) hose with metal spiral and "static wire". Can be used both as filling- or cooling water hose. Very flexible hose.

Öl- und Kühlwasser beständige Saug/Druckschlauch mit Stahlspiraleinlage und antistatischen Draht. Kann sowohl als Füll- oder Kühlwasserschlauch verwendet werden. Sehr biegsamer Schlauch.

Vacuüm: 0,8 bar Temp.bereik: -30 °C tot +100 °C

nr.	Ø / Q	werkdruk bar working pressure Arbeitsdruck	rollengte/role/Rolle
3350013	13/23	21	20
3350016	16/26	21	20
3350019	19/29	21	20
3350025	25/36	17	20
3350032	32/43	14	20
3350035	35/47	12	20
3350038	38/49	10	20
3350042	42/55	10	20
3350045	45/58	8	20
3350050	50/63	7	20
3350060	60/74	5	20

**KOELWATER-/HEETWATERSLANG 'CAR HEATER'
COOLING / HOT WATER HOSE
KÜHLWASSER/ HEISSWASSERSCHLAUCH**

Temp.bereik: -40°C tot +120°C

Bestand tegen gebruikelijke antivriesmiddelen en koelvloeistof

Resistant to the usual antifreeze and coolant

Beständig gegen übliche Frostschutz- und Kühlmittel

nr.	Ø / Q	werkdruk bar working pressure Arbeitsdruck	rollengte/role/Rolle
3120013	13/20	10	40
3120016	16/23	10	40
3120019	19/27	10	40

HOT WATER + 120°C

**HOT WATER SLANG
HOT WATER HOSE
HEISSWASSERSCHLAUCH**

Zeer soepele EPDM rubberen zuigpersslang voor warm- en zeewater. Met stalen spiraal.

Hot waterhose of special saltwater and heat resistant rubber.

Sehr flexibler EPDM-Gummi-Saug/druckschlauch für Heisswasser und salzwasser. Mit Stahlspiraleinlage.

Temp.bereik: -40°C tot 120°C

nr.	Ø / Q	werkdruk bar working pressure Arbeitsdruck	rollengte/role/Rolle
3351016	16/26	10	20
3351020	19/29	10	20
3351025	25/35	10	20
3351032	32/43	10	20
3351038	38/49	10	20
3351050	51/63	10	20
3351063	63,5	10	20

MERCUR 20 FUEL / OIL 25 X 35 MM WP/BP

MERCUR FUEL EN OIL

Olie en benzine bestendige rubberslang.

Smooth hose for fuel

Öl- und Benzinbeständiger Treibstoffschlauch

Barstdruk: 30 bar

Inwendig: nitrile rubber

Uitwendig: EPDM

Temp.bereik: -35°C tot +90°C

nr.	Ø / Q	werkdruk bar working pressure Arbeitsdruck	rollengte/role/Rolle
3320006	6/13	20	50 meter
3320008	8/15	20	50 meter
3320010	10/17	20	50 meter
3320013	13/20	20	50 meter
3320016	15/23	20	50 meter
3320019	19/27	20	50 meter
3320025	25/35	20	50 meter



**GEURDICHTE SANITARY SLANG
ANTI ODOR SANITATION HOSE
GERUCHSDICHTER SCHMUTZWASSER-
SCHLAUCH**

**MET 10 JAAR GARANTIE EN STALEN SPIRAAL
WITH 10-YEAR WARRANTY - MIT 10 JAHRE GARANTIE**

nr.	Ø / ʘ	werkdruk bar working pressure Arbeitsdruck	rollengte/role/Rolle
4494016	16/26	7	30,5
4494019	19/29	7	30,5
4494025	25/35	7	30,5
4494038	38/48	7	30,5



**FITT DIAMOND SANITAIRSLANG
SPIRAL REINFORCED HOSE
SCHMUTZWASSERSCHLAUCH**

10 jaar garantie productie, kwaliteit en geurdicht.
Metaalvrij en soepele slang

nr.	Ø / ʘ	werkdruk bar working pressure Arbeitsdruck	rollengte/role/Rolle
4493020	20/27.4	3	20
4493025	25/34	3	20
4493038	38/50	3	20
4493050	50/62	3	20



SANITAIRSLANG ●

nr.	Ø / ʘ	werkdruk bar working pressure Arbeitsdruck	rollengte/role/rolle
4491016	16/22.6	8	30
4491020	20/26	8	30



**PVC ZUIG/PERSSLANG MET STALEN SPIRAAL
TRADITIONAL SPIRAL HOSE
SAUG/DRUCKSCHLAUCH MIT STAHLSPIRALEINLAGE**

Temp.bereik: - 15 °C tot + 60 °.

nr.	Ø / ʘ	werkdruk bar working pressure Arbeitsdruck	rollengte/role/Rolle
4480010	10/16	7	30
4480013	13/19	7	30
4480016	16/22	6	30
4480019	20/27	5	30
4480025	25/33	5	30
4480032	32/40	4,5	30
4480035	35/43	4	30
4480038	38/47	4	30
4480040	40/50	3	30
4480045	45/55	3	30
4480050	50/62	3	30



**SANIFLEX MET STALEN SPIRAAL
SANIFLEX WITH STEEL SPIRAL INLAY
FÄKALIENSCHLAUCH MIT STAHLSPIRALEINLAGE**

- Niet geschikt voor gebruik met vuilwatertank
- Not for use in combination with wastewater tank
- Nicht für den Einsatz mit Abwassertanks geeignet

nr.	Ø / ʘ	rollengte/role/Rolle
4490016	16/21	30
4490020	19/26	30
4490025	25/33	30
4490032	32/40	30
4490038	38/46	30



BOILERSLANG

- DRINK- EN BOILERSLANG, BESTAND TEGEN KOELVLOEISTOF
- HOTWATERHOSE FOR BOILER, RESISTANT FOR COOLANT
- HEISSWASSERSCHLAUCH FÜR BOILER, BESTÄNDIG GEGEN KÜHLMITTEL

Temp.bereik: -40 °C - +120 °C
Binnenwand: EPDM
Buitenwand: EPDM
Kleur: Stip met blauw

nr.	Ø / ʘ	rollengte/role/Rolle
3472013	13/23	variabel
3472016	16/26	variabel
3472019	19/31	variabel



FITT NTS YELLOW

- PVC WATERSLANG
- PVC WATERHOSE
- PVC WASSERSCHLAUCH

Temp.bereik: - 10 °C tot + 40 °C
Barstdruk: 25 bar
Binnenwand: wit glad
Buitenwand: ●
Werkdruk bij 25°C: 10 bar

nr.	Ø / ʘ	rollengte/role/Rolle
41000125	12,5/17,5	50 meter
41000125/25	12,5/17,5	25 meter
4100019	19/25,5	50 meter
4100025	25/33	50 meter
4100032	32/40	50 meter
4100038	38/46	25 meter

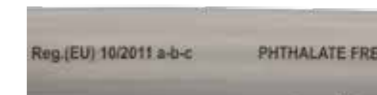

PVC-TRANSPARANT

- Temp -20°C tot +60°C
Transparante niet-versterkte slang voor veelzijdig gebruik.
Levensmiddelenkwaliteit.
- Transparant, non-reinforced PVC hose for general applications. Food quality.
- Transparanter, unverstärkter Kunststoff Wasserschlauch für vielseitigen Einsatz. Lebensmittelqualität.

nr.	Ø / ʘ	rollengte/role/Rolle
4041006	6/9	100 meter
4041008	8/12	50 meter
4041010	10/14	50 meter
4041012	12/16	50 meter
4041015	15/20	50 meter
4041019	19/25	50 meter
4041025	25/31	50 meter



FIT PURE

- DRINKWATERSLANG
- DRINKINGWATERHOSE
- TRINKWASSERSCHLAUCH

Temp.bereik: Temp -30°C tot + 70°C
Binnenwand: Dubbele NTS Plus gaas
Keur: EC 1935/2004 EC 10/2011

nr.	Ø / ʘ	rollengte/role/Rolle
4110013	12.3/17.5	50 meter
4110019	18.7/25.7	50 meter



AQUAFOOD

- DRINKWATERSLANG
- DRINKINGWATERHOSE
- TRINKWASSERSCHLAUCH

Temp.bereik: tot + 60°C
Binnenwand: blank transparant, glad
Rollengte: 50 meter

nr.	Ø / ʘ	
3470013	12.3/20	●
8300013	12.3/20	●



AIRCO SLANG AIRCOHOSE ABLUFTSCHLAUCH

Speciale kunststof slang geschikt voor de transport van lucht, gas, rook, vermindering van condensatie en geen verlies van warmte. Bij installeren let op de juiste blaasrichting. Anti-schimmel en anti-bacterie.

Special plastic hose with spiral suitable for transporting air, gas, smoke, reducing condensation and no loss of heat. When installing, pay attention to the correct blowing direction. Anti-fungal and anti-bacteria.

Kunststoffschauch mit Stahlspirale, für den Transport von u.a. Luft, Gas, Rauch und Kondens ohne Wärmeverlust geeignet. Achten Sie bitte bei der Installation auf die richtige Blasrichtung. Antimykotisch und antibakteriell.

Temp: -40 °C - +100 °C.

datasheet: www.dgrubberholland.nl

nr.	Ø	rollengte/role/Rolle
8400045	45	10
8400055	55	10
8400060	60	10
8400075	75	10
8400080	80	10
8400090	90	10
8400102	102	10
8400127	127	10
8400152	152	10
8400180	180	10
8400203	203	10
8400254	254	10

Op aanvraag leverbaar / on request / auf anfrag

nr.	Ø	rollengte/role/Rolle
8400040	40	10
8400051	51	10
8400110	110	10
8400305	300	10



PARALLAX

VERWARMINGS/AFZUIGSLANG
SINGEL WALL RUBBER SUCTION AND VENTILATION HOSE
EINWANDIGE GUMMI HEIZUNG/ABLUFTSCHLAUCH

Temp: -35 °C tot +135°C.

Enkelwandige zeer soepele zelfdovende afzuigslang, voor transport van lucht met een hoog eigen- en/of omgevingstemperatuur (kortstondig 150 graden celcius)

Very smooth self-extinguishing suction hose for transport of air and gasses with high ambient temperatures. Single wall

Hochflexibler, einwandiger und selbstverlöschender Abluftschlauch für den Transport von Luft und gasförmigen Medien mit einer hohen Eigen- oder Umgebungstemperatur (kurzzeitig 150 Grad Celsius).

nr.	W.D. bar	Ø	Vacuum %	rollengte/role/Rolle
8505060	1.1	60	40	4 meter
8505076	1.1	76	34	4 meter
8505080	1	80	32	4 meter
8505089	1	90	30	4 meter
8505102	1	102	26	4 meter



DELPHINUS

PVC AFZUIGSLANG
PVC SUCTION AND VENTILATION HOSE
KUNSTSTOFF ABSAUG- UND BELÜFTUNGSSCHLAUCH MIT PVC SPIRALE

Temp.bereik: -10 °C - +60 °C

nr.	Ø/Ø	rollengte/role/Rolle
4500020	20/25	50 meter
4500025	25/30	50 meter
4500030	30/36	50 meter
4500032	32/38	50 meter
4500035	35/41	50 meter
4500038	38/45	50 meter
4500050	50/57	50 meter



PVC COMPRESSOR SLANG PLASTIC COMPRESSOR HOSE KUNSTSTOFF-KOMPRESSORSCHLAUCH

Met polyester inlagen en lengtedraad. De luchtcompressor-slang bij uitstek. Door de toepassing van zeer hoogwaardige grondstoffen is deze slang zeer soepel en multifunctioneel.

Werkdruk: 20 bar

Temp. bereik: -20 °C tot +60 °C

Constructie: polyester inlagen, in- en uitwendig, glad met opdruk

Suitable for compressed air, water and mild chemicals

Geeignet für Druckluft, Wasser und leichte Chemikalien

nr.	Ø/Ø	werkdruk	rollengte/role/Rolle
4200006	6/12	20	50 meter
4200008	8/14	20	50 meter
4200010	10/16	20	50 meter
4200013	13/19	12	50 meter
4200016	16/22	10	50 meter
4200019	19/26	10	50 meter
4200025	25/33	8	50 meter
4200032	32/42	7	25 meter
4200038	38/48	6	25 meter
4200050	50/60	5	25 meter



BELINDA - AIR

W.D bar 20

Temp: -20°C tot +80°C

Rubber perslucht slang geschikt voor perslucht, water en niet agressieve producten.

Suitable for compressed air, water and non-aggressive products.

Gummi Druckluftschlauch geeignet für Druck/Pressluft, Wasser und nicht aggressiven Medien

nr.	Ø/Ø	rollengte/role/Rolle
3200006	6/13	50 meter
3200008	8/15	50 meter
3200010	10/18	50 meter
3200013	13/21	50 meter
3200019	19/29	50 meter



RADIATEURSLANG RADIATORHOSE KÜHLERSCHLAUCH

Bestand tegen de gebruikelijke antivries middelen.

Resistant to the usual antifreeze.

Beständig gegen übliche Frostschutzmittel.

Binnenwand: zwart glad

Buitenwand: zwart met doekafdruk

Temp.bereik: -40°C tot +120°C

Opdruk: DIN 73411, inw. diam. x wanddikte

nr.	Ø/Ø	werkdruk bar working pressure Arbeitsdruck	lengte
3117022	22/29	4	1 meter
3117025	25/32	4	1 meter
3117028	28/36	4	1 meter
3117030	30/38	4	1 meter
3117032	32/40	4	1 meter
3117035	35/43	4	1 meter
3117038	38/48	4	1 meter
3117040	40/50	4	1 meter
3117042	42/52	4	1 meter
3117045	45/55	4	1 meter
3117048	48/58	4	1 meter
3117050	50/60	4	1 meter
3117055	55/65	4	1 meter
3117060	60/70	4	1 meter
3117075	76/86	4	1 meter

L.D.A

LASDAMP AFZUIGSLANG
WELDING FUME EXTRACTION
SCHWEISSRAUCH ABSAUGUNG



Grijs vinyl gecoat synthetisch weefsel met vinyl ommantelde stalen spiraal.

Gray vinyl-coated synthetic fabric with vinyl coated steel spiral.

Grauer vinylbeschichteter Schlauch aus Synthetikgewebe mit Vinylbezogene Stahlspiraleinlage.

Temp. -10°C tot +180°C volgens brandklasse 1

nr.	Ø	rollengte/role/Rolle
4535076	76	6 meter
4535127	127	12 meter
4535152	152	10 meter
4535180	180	8 meter



HAND HEVELPOMP
MANUAL SIPHON PUMP
MANUELLE SHIPONPUMPE

nr.	
166611419	Blister verpakking



EPDM DEKWASLANG
ANTISTATISCH - ANTI-STATIC
Temp.bereik: - 40 °C tot + 110 °C

nr.	Ø / ∅	rollengte/role/Rolle
4440013	13/20	40 meter
4440019	19/27	40 meter
4440025	25/34	40 meter
4440032	32/44	40 meter
4440038	38/50	40 meter



SLANGLOSSER
HOSE UNLOADER
SCHLAUCHENTFERNER

nr.		
4400001	A	haaks/angled/ abgewinkelt
4400002	B	recht/straight/Gerade

BRANDSTOFSLANG
MET METAALOMVLECHTING
OIL OR GASOLINE HOSE
WITH STEEL BRAIDED COVER



ÖL- UND BENZINBESTÄNDIGER GUMMISCHLAUCH
MIT METALLGEWEBESCHUTZ

Temp.: -20°C tot +90°C

nr.	Ø / ∅	bar	rollengte/role/Rolle
3340006	6/11	25	25 meter
3340008	8/13	25	25 meter
3340010	10/15	25	25 meter
3340013	13/18	25	25 meter
3340016	16/21	25	25 meter

FITT-IKON

Gewicht besparende Flexibele slang
Ultra light Extentable hose
Ultra leichte, flexibele Schlauch



Bedrijfsdruk: 1>4 bar
Werktemp: -10>+50 C
Bestand tegen UV-straling

nr.	
215882	25 meter



FITT REFITEX PU

Flexibel.
Bestand tegen chemicaliën en slijtage.
100% PU en versterkt polyester.

Flexible.
Resistant against chemicals and abrasion.
100% PU and reinforced polyester

Flexibel.
Chemikalienbeständig und verschleissfest.
100% PU und verstärktes Polyester

Temp.: -30°C tot + 75°C

nr.		bar	e.h.
4200008/PU	8 x 12mm	20	100
4200010/PU	10 x 14,5mm	20	100



GEPERSTE GASLANGEN **GAS INSTALLATION HOSES** **GASSCHLÄUCHE**



glad / smooth / glatt

nr.	soort
991666001	verl.slang 60 cm 8mm knel x 8mm
991666002	verl.slang 80 cm 8mm knel x 8mm
991666016	verl.slang 100 cm 8mm knel x 8mm



glad / smooth / glatt

nr.	soort
991666004	verl.slang 60 cm 1/4 li.wartel x 8mm
991666005	verl.slang 80 cm 1/4 li.wartel x 8mm
991666006	verl.slang 100 cm 1/4 li.wartel x 8mm



nr.	soort
991666007	verl.slang 60 cm 1/4 li.wartel x 8mm knel
991666008	verl.slang 80 cm 1/4 li.wartel x 8mm knel
991666009	verl.slang 100 cm 1/4 li.wartel x 8mm knel



nr.	soort
991666010	verl.slang 60 cm 2x 1/4 li.wartel
991666011	verl.slang 80 cm 2x 1/4 li.wartel
991666012	verl.slang 100 cm 2x 1/4 li.wartel



nr.	soort
991666013	verl.slang 60 cm 2 x 8 mm knel
991666014	verl.slang 80 cm 2 x 8 mm knel
991666015	verl.slang 100 cm 2 x 8 mm knel



2x glad / 2x smooth / 2x glatt

nr.	soort
991666032	verl.slang 60 cm 2 x 8 mm
991666035	verl.slang 80 cm 2 x 8 mm
991666022	verl.slang 100 cm 2 x 8 mm

PROPAANGASSLANG
GASINSTALLATION HOSE
SCHLAUCH FÜR GASANLAGEN

NEN-EN 16436-1

nr.	inw./uitw.	rollengte
3265008.2	8/15	50 meter

CLASS 2-8 MM-10 BAR-PROPANE/BUTANE



**KLEMMEN
HOSE CLAMPS
SCHLAUCHSCHELLEN**

**MINIKLEMMEN**

GEGALVANISEERD - GALVANIZED

VERZINKT

W1

nr.	formaat	vpe
6005007	7 6-8	50
6005008	8 7-8	50
6005009	9 8-10	50
6005010	10 9-11	50
6005011	11 10-12	50
6005012	12 11-13	50
6005013	13 12-14	50
6005014	14 13-15	50
6005015	15 14-16	50
6005016	16 15-17	50
6005017	17 16-18	50
6005018	18 17-19	50
6005019	19 18-20	50

**MINIKLEMMEN**

RVS - STAINLESS STEEL - NIRO

W4

nr.	formaat	↔	vpe
6026007	7 6-8	9	50
6026008	8 7-9		50
6026009	9 8-10		50
6026010	10 9-11		50
6026011	11 10-12		50
6026012	12 11-13		50
6026013	13 12-14		50
6026014	14 13-15		50
6026015	15 14-16		50
6026016	16 15-17		50
6026017	17 16-18		50
6026018	18 17-19		50
6026019	19 18-20		50

WORMSCHROEFKLEMMEN
HOSE CLAMPS
SCHLAUCHSCHELLEN

RVS - STAINLESS STEEL - NIRO

Let op: W5 kwaliteit

Volledig roestvrijstalen W5 slangklemmen. Roestvrijstalen band W5 (AISI 316). Roestvrijstalen huis W5 (AISI 316). Roestvrijstalen schroef W5 (AISI 316). Conform DIN 3017 en SMS 2298

nr.	Ø / Ø	vpe
6011008	8/16	50
6011013	12/20	50
6011015	16/27	50
6011019	20/32	50
6011026	25/40	50
6011032	30/45	50
6011038	32/50	50
6011044	40/60	50
6011050	50/70	50
6011058	60/80	Los
6011068	70/90	Los
6011077	80/100	Los
6011087	90/110	Los

WORMSCHROEFKLEMMEN
HOSE CLAMPS
SCHLAUCHSCHELLEN

GEGALVANISEERD - GALVANIZED -

VERZINKT

Conform DIN 3017 en SMS 2298; schroef met zeskant. Band met gesloten fraising en voorzien van afgeronde kanten, zodat beschadiging van de slang wordt voorkomen. Gegalvaniseerd en gechromatiseerd. Voldoet aan de strengste eisen.

nr.	Ø / Ø	vpe
6000008	8/14	50
6000011	11/17	50
6000013	13/20	50
6000015	15/25	50
6000019	19/32	50
6000026	26/40	50
6000032	32/44	50
6000038	38/50	50
6000044	44/60	50
6000050	50/70	50
6000058	58/80	Los
6000068	68/90	Los
6000077	77/100	Los
6000087	87/110	Los

EINDKAP WORMSCHROEFKLEM
END CAP HOSE CLAMPS
SCHUTZKAPPE FÜR SCHLAUCHSCHELLEN

nr.		e.h.
6012000	12 mm	200
6012001	9 mm	200

LEIDINGKLEMMEN
CABLE / PIPE HOLDERS
SCHLAUCH-ROHRSCHELLEN

RVS - STAINLESS STEEL - NIRO

Roestvrijstalen band W5 (AISI) Voorzien van EPDM rubber. Bandbreedte: 13 mm

nr.	klembereik	vpe
6051006	4,8 - 6,4	100
6051008	7,9 - 9,5	100
6051010	9,5 - 11,1	50
6051013	12,7 - 14,3	50
6051016	15,9 - 17,5	50
6051021	20,6 - 22,2	50
6051029	28,6 - 30,2	50
6051035	34,9 - 36,5	10
6051045	44,5 - 47	10
6051051	51 - 54	10

LEIDINGKLEMMEN
CABLE / PIPE HOLDERS
SCHLAUCH-ROHRSCHELLEN

GEGALVANISEERD - GALVANIZED

VERZINKT

Voorzien van EPDM rubber.

Bandbreedte: 12 mm (conform DIN 3016)

nr.	klembereik	vpe
6054006	6	50
6054008	8	50
6054010	10	50
6054013	13	50
6054016	16	50
6054021	21	50
6054026	26	50
6054029	29	50
6054035	35	50
6054051	51	50

SUPERSTRENGHT KLEM
SUPERSTRENGHT CLAMP
GELENKBOLZENSCHELLE

1- DELIG GEGALVANISEERD

GALVANIZED - VERZINKT

Eëndelige zware slangklemmen, voorzien van een M8 bout.

Materiaal: gegalvaniseerd volgens DIN 50941

Staalbanddikte: 1,5 mm

nr.	Ø / Ø	staalbandbreedte
6200040	40/43	M8 20
6200044	44/47	M8 20
6200048	48/51	M8 20
6200052	52/55	M8 20
6200056	56/59	M8 20
6200060	60/63	M8 25
6200064	64/67	M8 25
6200068	68/73	M8 25
6200074	74/79	M8 25
6200080	80/85	M8 25
6200086	86/91	M8 25
6200092	92/97	M8 25
6200098	98/103	M8 25
6200104	104/112	M8 25
6200113	113/121	M8 25
6200122	122/130	M8 25
6200131	131/139	M8 25
6200140	140/148	M8 25
6200149	149/161	M8 25
6200162	162/174	M8 25
6200175	175/187	M8 25
6200188	188/200	M8 25
6200201	201/213	M8 25
6200214	214/226	M8 25
6200227	227/234	M8 25
6200240	240/252	M8 25
6200265	265/286	M8 25
6200270	270/280	M8 25
6200325	325/350	M8 25

SUPERSTRENGHT KLEM
SUPERSTRENGHT CLAMP
GELENKBOLZENSCHELLE

1- DELIG RVS W5 KWALITEIT

STAINLESS STEEL - NIRO

Eëndelige zware slangklemmen, voorzien van een M8 / M6 bout.

Materiaal band: RVS AISI 316, Bout: M8 A4, Moer: M8 A4 / M6 A4

Staalbanddikte: 1,5 mm

nr.	Ø / Ø	staalbandbreedte
6400026	26/28	M6 20
6400029	29/31	M6 20
6400032	32/35	M6 20
6400036	36/39	M6 20
6400040	40/43	M6 20
6400044	44/47	M6 20
6400048	48/51	M8 20
6400052	52/55	M8 20
6400056	56/59	M8 20
6400060	60/63	M8 25
6400063	64/67	M8 25
6400067	68/73	M8 25
6400074	74/79	M8 25
6400080	80/85	M8 25
6400086	86/91	M8 25
6400092	92/97	M8 25
6400095	98/103	M8 25
6400104	104/112	M8 25
6400110	113/121	M8 25
6400122	122/130	M8 25
6400132	131/139	M8 25
6400142	140/148	M8 25
6400152	149/161	M8 25
6400162	162/174	M8 25

SUPERSTRENGHT KLEM S
SUPERSTRENGHT CLAMP
SUPERSTARKE KLEMME S

1- DELIG RVS W5 KWALITEIT

nr.	klembereik	staalbandbreedte
6500026	26 - 28	M5 18



ENKELE OORKLEM
SINGLE EARCLIP
1-OHR-KLEMME

RVS - STAINLESS STEEL - NIRO

Deze enkele oorklem is aan de binnenkant glad en gemaakt uit band met W4 kwaliteit. Voor snelle en eenvoudige montage met behulp van tang 603000

This single earclip is smooth on the inside and made of W4 quality band.

for quick and easy mounting using pliers 603000

Dieser 1-Ohr-Klemme ist innen glatt und gefertigt aus Edelstahl, Material W4.

Für die Montage empfehlen wir das Zukneifen der Klemme mittels unserer Klemmzange Art.-Nr. 603000.

nr.	Ø / Ø	breedte	dikte
6034060	6/7	5	0,5
6034070	7/8,7	5	0,5
6034073	7,3/9	5	0,5
6034078	7,8/9,5	5	0,5
6034083	8,3/10	5	0,5
6034088	8,8/10,5	5	0,5
6034092	9,2/10,9	5	0,5
6034094	9,4/11,9	7	0,6
6034096	9,6/11,3	7	0,6
6034098	9,8/12,3	7	0,6
6034103	10,3/12,8	7	0,6
6034108	10,8/13,3	7	0,6
6034113	11,3/13,8	7	0,6
6034115	11,5/14	7	0,6
6034120	12/14,5	7	0,6
6034123	12,3/14,8	7	0,6
6034128	12,8/15,3	7	0,6
6034132	13,2/15,7	7	0,6
6034137	13,7/16,2	7	0,6
6034141	14,1/16,6	7	0,6
6034143	14,3/16,8	7	0,6
6034145	14,5/17	7	0,6
6034145B	14,5/17,8	7	0,6

nr.	Ø / Ø	breedte	dikte
6034148	14,8/18	7	0,6
6034150	15/17,5	7	0,6
6034153	15,3/18,5	7	0,6
6034160	16/19,2	7	0,6
6034166	16,6/19,8	7	0,6
6034178	17,8/21	7	0,6
6034194	19,4/22,6	7	0,6
6034203	20,3/23,5	7	0,6
6034209	20,9/24,1	7	0,6
6034224	22,4/25,6	7	0,6
6034239	23,9/27,1	7	0,6
6034254	25,4/28,6	7	0,6
6034269	26,9/30,1	7	0,6
6034276	27,6/30,8	7	0,6
6034284	28,4/31,6	7	0,6
6034299	29,9/33,1	7	0,6
6034314	31,4/34,5	7	0,6
6034329	32,9/42,5	7	0,6
6034393	39,3/42,5	7	0,6
6034408	40,8/44	7	0,6
6034655	65,5/67,3	7	0,6
6034663	66,3/69,5	7	0,6



ENDLESS BAND
ENDLESS BAND
ENDLOS BAND

RVS - STAINLESS STEEL - NIRO

Roestvrijstalen band W4 (AISI) Voorzien van EPDM rubber.

Bandbreedte: 12 mm

nr.	omschrijving	vpe
6012008	8mm breed met 8 losse klemmen lengte 3 meter	1
6012014	14 mm breed met 6 losse klemmen lengte 3 meter	1



TANG VOOR OORKLEMMEN
PLIERS FOR EARCLIPS
KLEMMZANGE FÜR OHRKLEMMEN

nr.	e.h.
603000	1



WORMSCHROEFKLEM TRIDON
HOSE CLAMPS TRIDON
SCHLAUCHSCHELLEN TRIDON

RVS - STAINLESS STEEL - NIRO

nr.	Ø / Ø	e.h.
6013019	20-30	1
6013020	20-35	1
6013027	24-51	1



DUBBELE KLEM
DOUBLE CLAMP
2-OHR-KLEMME

GEALVANISEERD - GALVANIZED

VERZINKT

Deze klem met 2 oren is gemaakt van buis W1 kwaliteit en is eenvoudig en daarmee eenmalig vast te zetten met behulp van speciale tang artnr. 603000

This clamp with 2ears is made of W1 quality tube and is easy to clamp with using special pliers artno. 603000

Diese 2-Ohr-Klemme ist gefertigt aus Rohr, Material W1.

Für die Montage empfehlen wir das Zukneifen der Klemme mittels unserer Klemmzange Art.-Nr. 603000.

nr.	Ø / Ø	breedte	dikte	oor
6031003	3/5	6	0,7	3,5
6031005	5/8	6	0,7	4
6031007	7/9	7	0,7	4,6
6031009	9/11	7	0,9	5,5
6031011	11/13	7	1	6
6031013	13/15	7,5	1	6,3
6031015	15/18	7,5	1,2	7
6031017	17/20	7,5	1,2	7,6
6031020	20/23	9	1,3	8,5
6031021	21/25	9	1,3	9,6
6031022	22/25	9	1,3	9,6
6031023	23/27	9	1,4	9,6
6031025	25/28	9	1,4	9,8
6031028	28/31	9,5	1,4	10
6031031	31/34	9,5	1,4	10,4
6031034	34/37	9,5	1,5	11
6031037	37/40	10	1,6	11,2
6031040	40/43	10	1,6	11,5
6031043	43/46	10	1,6	11,7



**FITWERK
FITTINGS
FITTINGE**



CR BOCHT 90 GRADEN BI/BUI
CR ELBOW MALE/FEMALE
CR WINKEL

AUSSEN/INNENGEWINDE

5830010/CR	3/8
5830013/CR	1/2
5830019/CR	3/4
5830025/CR	1"
5830032/CR	1 1/4
5830038/CR	1 1/2
5830050/CR	2"



CR BOCHT 45 GRADEN BI/BUI
CR ELBOW MALE/FEMALE
CR WINKEL

AUSSEN/INNENGEWINDE

5822010/CR	3/8
5822013/CR	1/2
5822019/CR	3/4
5822025/CR	1"
5822032/CR	1 1/4
5822038/CR	1 1/2
5822050/CR	2"



CR BOCHT 45 GRADEN BI
CR ELBOW FEMALE
CR WINKEL

INNENGEWINDE

5824010/CR	3/8
5824013/CR	1/2
5824019/CR	3/4
5824025/CR	1"
5824032/CR	1 1/4
5824038/CR	1 1/2
5824050/CR	2"



CR VERLOOPRING BI/BUI
CR REDUCING COUPLING
MALE/FEMALE
CR REDUZIERSTÜCK

AUSSEN/INNENGEWINDE

5860006/CR	1/4 x 3/8
5860013/CR	1/2 x 3/8
5860019/CR	1/2 x 3/4
5860025/CR	3/4 x 1"
5860032/CR	1" x 1 1/4
5860038/CR	1 1/2 x 1 1/4
58601325/CR	1/2 x 1"
58603250/CR	1 1/4 x 2"
58603825/CR	1" x 1 1/2
58605038/CR	2" x 1 1/2



CR SLANGPILAAAR BUITENDRAAD
CR HOSE CONNECTOR MALE
CR SCHLAUCHTÜLLE

AUSSENGEWINDE

53270606/CR	1/4 x 6 mm
53270608/CR	1/4 x 8 mm
53270610/CR	1/4 x 10 mm
53271008/CR	3/8 x 8 mm
53271010/CR	3/8 x 10 mm
53271013/CR	3/8 x 13 mm
53271016/CR	3/8 x 16 mm
53271308/CR	1/2 x 8 mm
53271310/CR	1/2 x 10 mm
53271313/CR	1/2 x 13 mm
53271316/CR	1/2 x 16 mm
53271320/CR	1/2 x 19 mm
53271915/CR	3/4 x 15 mm
53271920/CR	3/4 x 20 mm
53271925/CR	3/4 x 25 mm
53272520/CR	1" x 20 mm
53272525/CR	1" x 25 mm
53272532/CR	1" x 32 mm
53273225/CR	1 1/4 x 25 mm
53273232/CR	1 1/4 x 32 mm
53273238/CR	1 1/4 x 38 mm
53273832/CR	1 1/2 x 32 mm
53273840/CR	1 1/2 x 40 mm
53273850/CR	1 1/2 x 50 mm
53275050/CR	2" x 50 mm



CR DUBBELNIPPEL 2 X BUI
CR DOUBLENIPPEL 2 X MALE
CR DOPPELNIPPEL 2 X AUSSEN

5855006/CR	1/4
5855010/CR	3/8
5855013/CR	1/2
5855019/CR	3/4
5855025/CR	1"
5855032/CR	1 1/4
5855038/CR	1 1/2
5855050/CR	2"



CR SLANGPILAAAR BINNENDRAAD
CR HOSE CONNECTOR FEMALE
CR SCHLAUCHTÜLLE

INNENGEWINDE

53280610/CR	1/4 x 10 mm
53281010/CR	3/8 x 10 mm
53281014/CR	3/8 x 13 mm
53281313/CR	1/2 x 13 mm
53281316/CR	1/2 x 16 mm
53281320/CR	1/2 x 20 mm
53281920/CR	3/4 x 20 mm
53281925/CR	3/4 x 25 mm
53282525/CR	1" x 25 mm
53283232/CR	1 1/4 x 32 mm
53283240/CR	1 1/4 x 40 mm
53283838/CR	1 1/2 x 38 mm
53283850/CR	1 1/2 x 50 mm
53285050/CR	2" x 38 mm

CR KOGELKRAAN 2 X BI
CR BALLVALVE 2 X FEMALE
CR KUGELHAHN 2 X INNEN



CR SOK
CR JOINT SLEEVES
CR MUFFE

5835010/CR	3/8
5835013/CR	1/2
5835019/CR	3/4
5835025/CR	1"
5835032/CR	1 1/4
5835038/CR	1 1/2
5835050/CR	2"

CR VERLOOPNIPPEL 2 X BUI
CR DOUBLE REDUCING NIPPEL
2 X MALE

CR REDUZIERDOPPELNIPPEL
2 X AUSSENGEWINDE

5850006/CR	1/4 x 3/8
5850013/CR	1/2 x 3/8
5850019/CR	3/4 x 1/2
5850025/CR	1" x 3/4
5850032/CR	1 1/4" x 1"
5850038/CR	1 1/2" x 1 1/4"
5850050/CR	2" x 1 1/2
58501325/CR	1/2" x 1"
58505032/CR	1 1/4" x 2"

5243010	3/8
5243013	1/2
5243019	3/4
5243025	1"
5243032	1 1/4
5243038	1 1/2
5243050	2"

CR HUIDDOORVOER
CR THREADED THRU HULL
FITTING
BORDDURCHFÜHRUNG

5810010/CR	3/8
5810013/CR	1/2
5810019/CR	3/4
5810025/CR	1"
5810032/CR	1 1/4
5810038/CR	1 1/2
5810050/CR	2"

CR HUIDDOORVOER
MET ZEEF
CR THRU HULL
SCOOPSTRAINER
BORDDURCHFÜHRUNG MIT

SIEB

5811010/CR	3/8
5811013/CR	1/2
5811019/CR	3/4
5811025/CR	1"
5811032/CR	1 1/4
5811032/CR	1 1/4
5811050/CR	2"

CR BOCHT 90 GRADEN BI/BUI
CR ELBOW FEMALE
CR WINKEL

INNENGEWINDE

5825006/CR	1/4
5825010/CR	3/8
5825013/CR	1/2
5825019/CR	3/4
5825025/CR	1"
5825032/CR	1 1/4
5825038/CR	1 1/2
5825050/CR	2"

CR T-STUK BINNENDRAAD
CR T-CONNECTOR FEMALE
T-STÜCK

INNENGEWINDE

5820010/CR	3/8
5820013/CR	1/2
5820019/CR	3/4
5820025/CR	1"
5820032/CR	1 1/4
5820038/CR	1 1/2
5820050/CR	2"



CR KOPPELING 3-DELIG BI-BI
CR COUPLING 3-PARTS FEM/FEM
CR VERSCHRAUBUNG 3 TEILIG
 INNEN/INNENGEWINDE

nr.	maat
5835125/CR	1"
5835132/CR	1¼"
5835138/CR	1½"
5835150/CR	2"

CR KOPPELING 3-DELIG BI-BU
CR COUPLING 3-PARTS FEM/MALE
CR VERSCHRAUBUNG 3 TEILIG
 AUSSEN/INNENGEWINDE

nr.	maat
5836125/CR	1"
5836132/CR	1¼"
5836138/CR	1½"
5836150/CR	2"

CR DRAADEIND
CR EXTENSION
GEWINDEROHR

Lengte / length / Länge 1 meter

nr.	maat
5817013/CR	½"
5817019/CR	¾"
5817025/CR	1"



CR DOP SOK BINNENDRAAD
CR THREAD FEMALE
GEWINDEKAPPE

nr.	verp.eenheid	maat
5840006/CR	5	¼"
5840010 /CR	5	¾"
5840013/CR	5	½"
5840019/CR	5	¾"
5840025/CR	5	1"
5840032/CR	1	1¼"
5840038/CR	1	1½"
5840050/CR	1	2"

CR PLUG BUITENDRAAD
CR THREAD PLUGS MALE
GEWINDESTOPF

nr.	verp.eenheid	maat
5845003/CR	5	⅙"
5845006/CR	5	¼"
5845010 /CR	5	¾"
5845013/CR	5	½"
5845019/CR	5	¾"
5845025/CR	5	1"
5845038/CR	1	1½"
5845050/CR	1	2"

CR LOSSE RING
CR WASHER
CR UNTERLEGSCHIEBE

nr.	maat
58640010/CR	⅝"
58640013/CR	½"
58640019/CR	¾"
58640025/CR	1"
58640032/CR	1¼"
58640038/CR	1½"
58640050/CR	2"

CR MOER ZONDER RING
CR NUT WITHOUT WASHER
CR MUTTER OHNE UNTERLEGSCHIEBE

nr.	maat
58670006/CR	¼"
58670010/CR	⅜"
58670013/CR	½"
58670019/CR	¾"
58670025/CR	1"
58670032/CR	1¼"
58670038/CR	1½"
58670050/CR	2"



CR VERLOOPSOK BI
CR PIPESLEEVE FEMALE
CR REDUZIERMUFFE

nr.	maat
5836019/CR	½ x ¾"
5836038/CR	1½ x 1¼"

BRONS FITWERK

STEDS VAKER IS CR HET VERVANGENDE FITWERK VOOR BRONS. ECHTER ZIJN ER EEN AANTAL SITUATIES WAARIN DIT TOCH GEADVISEERD WORDT.

WANNEER ADVISEREN WIJ BRONS:

Als een waterfilter met een maatvoering van 2" of groter is opgenomen in het systeem van fitwerk. Onze waterfilters zijn tot en met 1 1/2" in CR leverbaar, bij grotere maten alleen in brons. Indien het systeem geen waterfilter bevat kan in de grote maten ook het CR fitwerk toegepast worden.

Ons advies is tevens om fitwerk altijd van hetzelfde materiaal te gebruiken: RVS op RVS, messing op messing enz.

WHEN DO WE RECOMMEND BRONZE:

If a water filter is included in the system and the dimensions are 2" or larger. Our water filters are up to 1 1/2" available in CR, larger diameters only in bronze. If the system does not contain a water filter, CR items can also be used for larger diameters. We also recommend always to use the same materials in the entire system: stainless steel on stainless steel, brass on brass, etc.

WANN EMPFEHLEN WIR BRONZE:

Wenn ein Wasserfilter im System enthalten ist und der Durchmesser 2 Zoll oder mehr beträgt. Unsere Wasserfilter sind bis zu 1 1/2 Zoll in CR erhältlich, grössere Durchmesser nur in Bronze. Wenn das System keinen Wasserfilter enthält, kann CR auch für grössere Durchmesser verwendet werden.

Wir empfehlen ausserdem, das gesammte System immer aus den gleichen Materialien zusammenzustellen: Edelstahl auf Edelstahl, Messing auf Messing usw.

VOORRADIG
IN STOCK
VORRÄTIG

nr.		maat
53276365/B	Slangpilaar BU	2½ x 65
5550063/B	Kogelkraan BI-BI	2½"
5810063/B	Huiddoorvoer	2½"
8615050 en <	Koelwaterfilter ZIJ - ONDER UITLAAT	2" en <
8620050 en <	Koelwaterfilter ZIJ - ZIJ UITLAAT	2" en <
86110063/B	Zeef	
5577010 en <	Snelsluitkraan BI-BI	blz. 107 ⅜ en <

LET OP! Alle messing en CR fitwerk is op verzoek te bestellen als bronzen fitwerk!

NOTE! All our brass and CR items can be ordered in bronze upon request.

ACHTUNG! Alle unsere Messing- und CR-Artikel können auf Anfrage in Bronze bestellt werden.





PP HUIDDOORVOER
PP THREADED SKINFITTING
PP BORDDURCHFÜHRUNG

5658013	○	1/2
5658019	○	3/4
5658025	○	1"
5658032	○	1 1/4
5658038	○	1 1/2
5658050	○	2"



PP HUIDDOORVOER
PP THREADED SKINFITTING
PP BORDDURCHFÜHRUNG

5645013	●	1/2
5645019	●	3/4
5645025	●	1"
5645032	●	1 1/4
5645038	●	1 1/2
5645050	●	2"



AFB A



AFB B

PP KOGELKRAAN 2 X BI
PP BALLVALVE 2 X FEMALE
PP KUGELHAHN 2 X INNEN

5620013	A	1/2
5620019	A	3/4
5620025	A	1"
5620032	B	1 1/4
5620038	B	1 1/2
5620050	B	2"



PP BOCHT 90 GRADEN 2 X BI
PP ELBOW 2 X FEMALE
PP WINKEL INNENGEWINDE

5630013	1/2
5630019	3/4
5630025	1"
5630032	1 1/4
5630038	1 1/2
5630050	2"



PP T-STUK
PP T-CONNECTOR
PP T-STÜCK

5618013	1/2
5618019	3/4
5618025	1"
5618032	1 1/4
5618038	1 1/2
5618050	2"



PP BOCHT 90 GRADEN BI/BIU
PP ELBOW MALE/FEMALE
PP WINKEL AUSSEN/INNENGEWINDE

5628013	1/2
5628019	3/4
5628025	1"
5628032	1 1/4



PP VERLOOPNIPPEL
PP REDUCING NIPPEL
PP REDUZIERNIPPEL

5660013	1/2 x 3/8 mm
5660019	3/4 x 1/2 mm
5660025	1" x 3/4 mm
5660032	1 1/4" x 1" mm
5660038	1 1/2" x 1" mm
56603832	1 1/2" x 1 1/4" mm
5660050	2" x 1 1/2" mm



PP DUBBELNIPPEL 2 X BUI
PP DOUBLENIPPEL 2 X MALE
PP DOPPELNIPPEL 2 X AUSSEN

5615013	1/2
5615019	3/4
5615025	1"
5615032	1 1/4
5615038	1 1/2
5615050	2"



PP NEUSSTUK
PP SLEEVE
PP ROHRMUFFE

5770019	3/4 x 1/2
---------	-----------



PP VERLOOPRING BI/BIU
PP REDUCING COUPLING
MALE/FEMALE
PP RUDUZIERSTÜCK
AUSSEN/INNENGEWINDE

56321913	3/4 x 1/2"
56322513	1" x 1/2"
56322519	1" x 3/4"
56323213	1 1/4 x 1/2"
56323219	1 1/4 x 3/4"
56323225	1 1/4 x 1"
56323819	1 1/2 x 3/4"
56323825	1 1/2 x 1"
56323832	1 1/2 x 1 1/4"
56325025	2 x 1"
56325032	2 x 1 1/4"
56325038	2 x 1 1/2"



PP SLANGPILAAR BUITENDRAAD
PP HOSE CONNECTOR MALE
PP SCHLAUCHTÜLLE
AUSSENGEWINDE

56101310	1/2 x 10 mm
56101313	1/2 x 13 mm
56101316	1/2 x 16 mm
56101320	1/2 x 20 mm
56101325	1/2 x 25 mm
56101913	3/4 x 13 mm
56101916	3/4 x 16 mm
56101920	3/4 x 20 mm
56101925	3/4 x 25 mm
56102520	1" x 20 mm
56102525	1" x 25 mm
56102532	1" x 32 mm
56103225	1 1/4 x 25 mm
56103232	1 1/4 x 32 mm
56103238	1 1/4 x 38 mm
56103838	1 1/2 x 38 mm
56103850	1 1/2 x 50 mm
56105050	2" x 50 mm



PP SLANGPILAAR BUITENDRAAD
PP HOSE CONNECTOR MALE
PP SCHLAUCHTÜLLE
AUSSENGEWINDE

56202919	●	3/4 x 19 mm
56202920	●	3/4 x 20 mm





PP TANKADAPTER/DOORVOER
PP TANKADAPTER/FITTING
PP TANKADAPTOR/DURCHFÜHRUNG

Deze is van 1 kant te monteren. Ideaal bij moeilijke bereikbaarheid.
 Can be mounted from 1 side. Ideal if it is difficult to reach.
 Von einer Seite montierbar. Ideal für schwierige Zugänglichkeit.

Wanddikte: 2>10 mm
 Wallthickness: 2>10 mm
 Wandstärke: 2>10 mm

nr.	G1	E	E1	D	H	L2	K
5741050303	1/2"	29	37	13	49	5	28
5741050505	3/4"	35	43	18	52	4	32
5741050707	1"	43	53	24	56	7	41
5741050909	1 1/4"	52	62	29,5	65	6	50
5741051111	1 1/2"	59	68	34,5	75	16	57
5741051515	2"	70	80	34,5	91	31	70

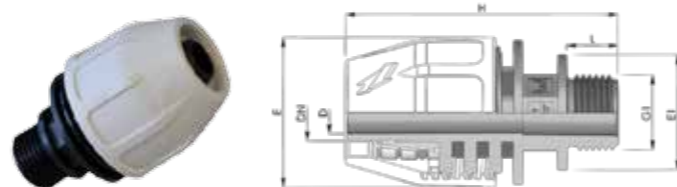

**PP BD FAST COMPACT RECHTE KOPPELING
 VOOR GEBRUIK MET SLANG**
**PP BD FAST COMPACT STRAIGHT COUPLING
 FOR USE WITH HOSE**
**PP BD SCHNELLE KOMPAKTE GERADE KUP-
 PLUNG ZUR VERWENDUNG MIT SCHLAUCH**

16 bar bij 20 graden
 -5>80 graden

nr.	DN mm (inch)	G1	D	L	H	E	E1
5740050210	10 (3/8")	1/2"	7,5	11	91	34,5	32
5740050313	13 (1/2")	1/2"	9,5	14,5	77	38	32
5740050316	16 (5/8")	1/2"	12	14,5	83	42	32
5740050320	20 (25/32")	1/2"	15	14,5	88	49	32
5740050513	13 (1/2")	3/4"	9,5	16	80	38	38
5740050516	16 (5/8")	3/4"	12	16	85	42	38
5740050520	20 (25/32")	3/4"	15	16	90	49	39

PP QJ Tankadapter huiddoorvoer



Deze nieuwe tankadapter en huiddoorvoer kan vanaf 1 zijde gemonteerd worden zonder tussenkomst van een extra borgmoer. Ideaal als 1 zijde moeilijk of niet bereikbaar is. Past op een materiaal dikte tussen 2mm en 10mm.

Technische Informatie

Materiaal : Glasvezelversterkt Polypropyleen (PP)
 Kleur : Zwart (RAL 9011)
 Werkdruk : 4 bar bij 20°C
 Maximale werk temperatuur : 80°C

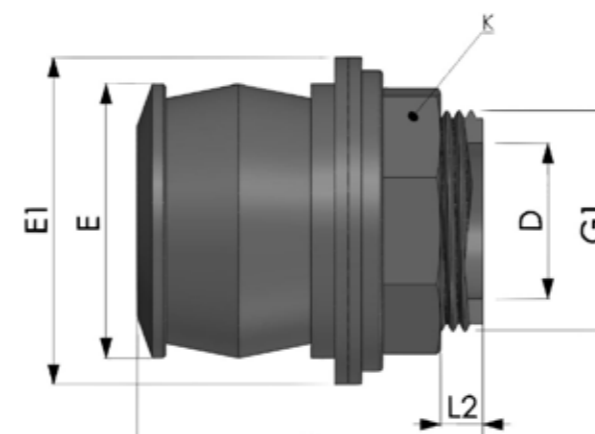

Tankadapter huiddoorvoer

Artikelnr	G1	E	E1	D	H	L2	K
5741050303	1/2"	29	37	13	49	5	28
5741050505	3/4"	35	43	18	52	4	32
5741050707	1"	43	53	24	56	7	41
5741050909	1 1/4"	52	62	29,5	65	6	50
5741051111	1 1/2"	59	68	34,5	75	16	57
5741051515	2"	70	80	34,5	91	31	70

Tankadapter is er naast PP (geschikt voor water) ook op verzoek leverbaar als NBR (brandstoffen), FKM (agressieve vloeistoffen), en Messing. Eveneens leveraar als buiten- als binnendraad. In de Tabel staat de PP uitvoering met buitendraad en die hebben wij voorradig.



ALGEMEEN FITWERK

FITWERK OVERIGE UITVOERINGEN
OP AANVRAAG LEVERBAAR

KOELWATERFILTER COOLINGWATERSTRAINER KÜHLWASSERFILTER

Met transparante deksel, zij-onder uitlaat
With transparant cap, side-under
Mit Klarsichtdeckel, Seite-Unten Anschlüsse



8615025	Messing	1"
8615038	Messing	1 1/2"

Bovenstaand ook beschikbaar in CR en Brons.

8615050	Brons	2"
8615065	Brons	2 1/2"
8615075	Brons	3"

KOELWATERFILTER COOLINGWATERSTRAINER KÜHLWASSERFILTER

Bodemmontage - floor mounting - Bodenbefestigung
Koelwaterfilter 2x zijuitlaat



8620025	Messing	1"
8620038	Messing	1 1/2"

Bovenstaand ook beschikbaar in CR en Brons.

8620050	Brons	2"
8620065	Brons	2 1/2"
8620075	Brons	3"

MESSING DRAADEIND EXTENSION GEWINDEROHR

Lengte / length / Länge 1 meter

5817013	1/2"
5817019	3/4"
5817025	1"
5817032	1 1/4"
5817038	1 1/2"
5817050	2"



KLEINE WIERPOT 3/4 COMPLEET STRAINER COMPLETE 3/4 WASSERFILTER KOMPLETT 3/4

8610019	
8611019	Losse sleutel / spare key / Schlüssel
8610019.2	Uitvoering metalen deksel Version metal cap Ausführung mit Metalldeckel

ANODE VOOR RVS MANDJE ANODE FOR STAINLESS STEEL BASKET ANODE FÜR EDELSTAHLKORB

Vanaf/from/von 2"

8615001	Anode
---------	-------



ONTLUCHTINGSNIPPELS PLAT FUELVENT FLAT ENTLÜFTUNGS NIPPEL

58711116	Haaks/elbow/winkel	16
58722216	Recht/straight/Gerade	16



BELUCHTER / OVERLOOP AERATOR / OVERFLOW BELÜFTER / ÜBERLAUF

58733319	A	1/2 x 3/4 x 3/4
58733332	A	1/2 x 1 1/4 x 1 1/4
58744413	B	1/2 x 10 mm



HUIDDOORVOER THREADED SKINFITTING FLARED HEAD BORDDURCHFÜHRUNG

5810006	1/4"
5810010	3/8"
5810013	1/2"
5810019	3/4"
5810025	1"
5810032	1 1/4"
5810038	1 1/2"
5810050	2"



MESSING HUIDDOORVOER MET ZEEF THRU HULL SCOOPSTRAINER MESSING BORDDURCH- FÜHRUNG MIT SIEB

5811010	3/8"
5811013	1/2"
5811019	3/4"
5811025	1"
5811032	1 1/4"
5811038	1 1/2"
5811050	2"



VERCHROOMDE HUIDDOORVOER CHROMET PLATED BRASS BORDDURCHFÜHRUNG CHROM BOL / ROUNDED / KONVEX

5812010	3/8"
5812013	1/2"
5812019	3/4"
5812025	1"
5812032	1 1/4"
5812038	1 1/2"



VERCHROOMDE HUIDDOORVOER CHROMET PLATED BRASS BORDDURCHFÜHRUNG CHROM

HOL / FLAT HEAD / FLACH

5814010	3/8"
5814013	1/2"
5814019	3/4"
5814025	1"
5814032	1 1/4"
5814038	1 1/2"



MESSING HUIDDOORVOER BRASS SKINFITTING BORDDURCHFÜHRUNG CHROM KONVEX 100 mm lang / long / Länge

5810113	1/2"
5810119	3/4"
5810125	1"
5810132	1 1/4"
5810138	1 1/2"



MESSING HUIDDOORVOER MET SLANGPILAAR WITH HOSECONNECTOR BORDDURCHFÜHRUNG MIT SCHLAUCHTÜLLE

5818013	13	1/4"
5818016	15	3/8"
5818019	19	1/2"
5818025	25	1"
5818032	32	1 1/4"
5818038	38	1 1/2"

NBR RINGEN RINGS RINGE

huiddoorvoer/skinfitting/Borddurchführung

22123	1/4"
35173	3/8"
30213	1/2"
39293	3/4"
53343	1"
65433	1 1/4"
70483	1 1/2"



DEKVULDOP MET SLEUTEL DECK FILLER WITH KEY EINFÜLLSTUTZ MIT SCHLÜSSEL

5809238	water / water / Wasser	38 mm
5809138	diesel / fuel / Treibstoff	38 mm
5809250	water / water / wasser	50 mm
5809150	diesel / fuel / Treibstoff	50 mm



**MESSING BOCHT
90 GRADEN BI/BI**
BRASS ELBOW MALE/FEMALE
MESSING WINKEL
AUSSEN/INNENGEWINDE

5830003	5	1/8
5830006	5	1/4
5830010	5	3/8
5830013	5	1/2
5830019	5	3/4
5830025	5	1"
5830032	1	1 1/4
5830038	1	1 1/2
5830050	1	2"



**MESSING BOCHT
45 GRADEN 2 X BI**
BRASS ELBOW 2 X FEMALE
MESSING WINKEL
2 X INNENGEWINDE

5824010	1	3/8
5824013	1	1/2
5824019	1	3/4
5824025	1	1"
5824032	1	1 1/4
5824038	1	1 1/2
5824050	1	2"



**MESSING BOCHT
45 GRADEN BI/BI**
BRASS ELBOW MALE/FEMALE
MESSING WINKEL
AUSSEN/INNENGEWINDE

5822010	1	3/8
5822013	1	1/2
5822019	1	3/4
5822025	1	1"
5822032	1	1 1/4
5822038	1	1 1/2
5822050	1	2"



MESSING T-STUK 3 X BI
BRASS T-CONNECTOR
3 X FEMALE
MESSING T-STÜCK
3 X INNENGEWINDE

5820003	5	1/8
5820006	5	1/4
5820010	5	3/8
5820013	5	1/2
5820019	5	3/4
5820025	5	1"
5820032	1	1 1/4
5820038	1	1 1/2
5820050	1	2"



MESSING SOK BINNENDRAAD
BRASS JOINT SLEEVES
FEMALE
MESSING ROHRMUFFE
INNENGEWINDE

5835004	5	1/8
5835006	5	1/4
5835010	5	3/8
5835013	5	1/2
5835019	5	3/4
5835025	5	1"
5835032	1	1 1/4
5835038	1	1 1/2
5835050	1	2"



**MESSING BOCHT 90
GRADEN 2X BI**
BRASS ELBOW 2 X FEMALE
MESSING WINKEL
2 X INNENGEWINDE

5825003	5	1/8
5825006	5	1/4
5825010	5	3/8
5825013	5	1/2
5825019	5	3/4
5825025	5	1"
5825032	1	1 1/4
5825038	1	1 1/2
5825050	1	2"



**MESSING VERLOOP-
NIPPEL MET ZESKANT**
**BRASS DOUBLE NIPPLE
REDUCED**
MESSING REDUZIERNIPPEL

5850003	5	1/8 x 1/4
5850006	5	1/4 x 3/8
58500613	5	1/4 x 1/2
5850013	5	3/8 x 1/2
5850019	5	1/2 x 3/4
5850025	5	3/4 x 1"
5850032	1	1" x 1 1/4
5850038	1	1 1/4 x 1 1/2
5850050	1	1 1/2 x 2"



**MESSING DUBBELNIPPEL
MET ZESKANT**
BRASS DOUBLENIPPEL
MESSING DOPPELNIPPEL

5855003	5	1/8
5855006	5	1/4
5855010	5	3/8
5855013	5	1/2
5855019	5	3/4
5855025	5	1"
5855032	1	1 1/4
5855038	1	1 1/2
5855050	1	2"

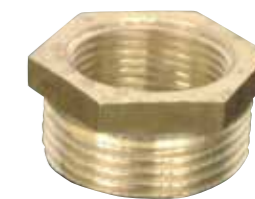

**MESSING VERLOOPRING
BI/BI**
**BRASS REDUCING
COUPLING MALE/FEMALE**
MESSING REDUZIERNIPPEL
AUSSEN/INNENGEWINDE

58600313	5	1/8 x 1/2
58600319	5	1/8 x 3/8
5860003	5	1/4 x 1/8
5860006	5	1/4 x 3/8
58600619	5	1/4 x 3/4
58601019	5	3/8 x 3/4
58601025	5	3/8 x 1"
58600613	5	1/2 x 1/4
5860013	5	1/2 x 3/8
58601325	5	1/2 x 1"
58601332	1	1/2 x 1 1/4
5860019	5	3/4 x 1/2
5860025	5	1" x 3/4
58603219	1	1 1/4 x 3/4
5860032	1	1 1/4 x 1"
5860038	1	1 1/2 x 1/4
58603819	1	1 1/2 x 3/4
58603825	1	1 1/2 x 1"
58605038	1	2" x 1 1/2



MESSING VERLOOPSOK BI
**BRASS REDUCED
PIPESLEEVE FEMALE**
MESSING REDUZIERMUFFE
INNENGEWINDE

5836004	1	1/4 x 1/8
5836006	1	1/4 x 3/8
58360613	1	1/4 x 1/2
5836013	1	1/2 x 3/8
58361325	1	1/2 x 1"
5836019	1	3/4 x 1/2
5836025	1	1" x 3/4
5836032	1	1 1/4 x 1"
5836038	1	1 1/2 x 1 1/4



MESSING DOP SOK BI
BRASS THREAD FEMALE
MESSING GEWINDEKAPPE
INNENGEWINDE

5840004	5	1/8
5840006	5	1/4
5840010	5	3/8
5840013	5	1/2
5840019	5	3/4
5840025	5	1"
5840032	1	1 1/4
5840038	1	1 1/2
5840050	1	2"



MESSING PLUG BUITENDRAAD
BRASS THREAD PLUGS MALE
MESSING GEWINGESTOPF
AUSSENGEWINDE

5845003	5	1/8
5845006	5	1/4
5845010	5	3/8
5845013	5	1/2
5845019	5	3/4
5845025	5	1"
5845032	1	1 1/4
5845038	1	1 1/2
5845050	1	2"



**MESSING SLANGPILAAR
HOSE CONNECTOR
SCHLAUCHTÜLLE**

BUITENDRAAD/MALE/AUSSENGEWINDE

nr.	verp.eenheid	maat	tule
53270306	5	1/8	6
53270308	5	1/8	8
53270310	5	1/8	10
53270606	5	1/4	6
53270608	5	1/4	8
53270610	5	1/4	10
53270613	5	1/4	13
53270616	5	1/4	16
53271008	5	3/8	8
53271010	5	3/8	10
53271013	5	3/8	13
53271016	5	3/8	16
53271308	5	1/2	8
53271310	5	1/2	10
53271313	5	1/2	13
53271316	5	1/2	16
53271320	5	1/2	20
53271913	5	3/4	13
53271915	5	3/4	16
53271920	5	3/4	20
53271925	5	3/4	25
53272520	5	1"	20
53272525	5	1"	25
53272532	5	1"	32
53273225	1	1 1/4	25
53273232	1	1 1/4	32
53273238	1	1 1/4	38
53273832	1	1 1/2	32
53273838	1	1 1/2	38
53273845	1	1 1/2	45
53273850	1	1 1/2	50
53275045	1	2"	45
53275050	1	2"	51
53275060	1	2"	60
53276565	1	2 1/2	65
53277676	1	3"	76



**MESSING SLANGPILAAR
HOSE CONNECTOR
SCHLAUCHTÜLLE**

BINNENDRAAD / FEMALE / INNENGEWINDE

nr.	verp.eenheid	maat	tule
53280610	5	1/4	10
53281010	5	3/8	10
53281014	5	3/8	13
53281015	5	3/8	16
53281313	5	1/2	13
53281316	5	1/2	16
53281320	5	1/2	20
53281920	5	3/4	20
53281925	5	3/4	25
53282525	5	1"	25
53283232	1	1 1/4	32
53283838	1	1 1/2	38
53285050	1	2"	50



**NEUSSTUK
SLEEVE
ROHRMUFFE**

nr.	verp.eenheid	maat
58700603	1	1/4 x 1/8
58701006	1	3/8 x 1/4
58701306	1	1/2 x 1/4
58701310	1	1/2 x 3/8
58701913	1	3/4 x 1/2
58702519	1	1" x 3/4



**MESSING CONNECTIEMOER
BRASS CONNECTIONNUT
MESSING SECHSKANT-
MUTTER**

MET FLENS / WITH FLANGE / MIT FLANSCH

nr.	verp.eenheid	maat
58650010	1	3/8
58650013	1	1/2
58650019	1	3/4
58650025	1	1"
58650032	1	1 1/4
58650038	1	1 1/2
58650050	1	2"



**LOSSE RING
WASHER
UNTERLEGSCHIEBE**

nr.	maat
58640006	1/4
58640010	3/8
58640013	1/2
58640019	3/4
58640025	1"
58640032	1 1/4
58640038	1 1/2
58640050	2"



**LOSSE MOER
NUT WITHOUT WASHER
MUTTER OHNE UNTER-
LEGSCHIEBE**

nr.	maat
58670006	1/4
58670010	3/8
58670013	1/2
58670019	3/4
58670025	1"
58670032	1 1/4
58670038	1 1/2
58670050	2"



**MESSING 3-DELIGE
KOPPELING BI/BUI
BRASS 3-PIECE COUPLING IN/OUT
MESSING VERSCHRAUBUNG
3 TEILIG AUSSEN/INNENGEWINDE**

nr.	maat
5836106	1/4
5836110	3/8
5836115	1/2
5836119	3/4
5836125	1
5836132	1 1/4
5836138	1 1/2
5836150	2
5836165	2 1/2
5836176	3



**MESSING 3-DELIGE
KOPPELING 2 X BI
BRASS 3-PIECE COUPLING
2 X INSIDE
MESSING VERSCHRAU-
BUNG 3 TEILIG
2 X INNENGEWINDE**

nr.	maat
5835119	3/4
5835125	1
5835150	2

**GEKA SNELKOPPELINGEN VOOR WATER EN LUCHT
GEKA QUICKCOUPLING FOR WATER AND AIR
GEKA SCHNELLKUPPLUNG FÜR WASSER UND LUFT**

Nokafstand / camdistance / Nockenabstand: 40 mm
Werkdruk / workload / Betriebsdruck: • Voor water/for water/für Wasser: max. 40 bar • Voor lucht /for air/für Luft: max. 30 bar



**AANSLUITSTUK
CONNECTION PIECE
SCHNELLKUPPLUNG**

VOOR SLANG - FOR HOSE - FÜR SCHLAUCH

nr.	Ø
5310010	10
5310013	13
5310016	16
5310019	19
5310025	25
5310032	32
5310038	38



**AANSLUITSTUK
CONNECTIONPIECE
SCHNELLKUPPLUNG**

MET BINNENDRAAD BSP - WITH BSP FEMALE
THREAD - MIT BSP INNENGEWINDE

nr.	Ø
5311010	3/8
5311013	1/2
5311019	3/4
5311025	1"
5311032	1 1/4
5311038	1 1/2



**AANSLUITSTUK
CONNECTIONPIECE
SCHNELLKUPPLUNG**

MET BUITENDRAAD BSP - WITH BSP MALE
THREAD - MIT BSP AUSSENGEWINDE

nr.	Ø
5312010	3/8
5312013	1/2
5312019	3/4
5312025	1"
5312032	1 1/4
5312038	1 1/2



MESSING BLINDKAP BLIND CAPS BLINDKAPPE
VOOR ALLE KOPPELINGEN - FOR ALL COUPLINGS - FÜR ALLE KUPPLUNGEN

nr.
5313040



MESSING VEERBELASTE VOETKLEP
SPRING-LOADED VALVE WITH SUCTION STRAINER
ANSAUGSIEB MIT RÜCKSCHLAGVENTIL

nr.	bi / fem / innen	H x B	werkdruk bar
5225013	½	67 x 34	10
5225019	¾	78 x 42	10
5225025	1"	92 x 48	10
5225032	1¼	104 x 56	8
5225038	1½	118 x 71	8
5225050	2"	134 x 88	8



MESSING VEERBELASTE TUSSENKLEP
BRASS SPRING-LOADED INTERMEDIATE VALVE
MESSING RÜCKSCHLAGVENTIL

nr.	bi / fem / innen	↕ x ↔	werkdruk bar
5226013	½	48 x 34	12
5226019	¾	53 x 42	12
5226025	1"	58 x 48	12
5226032	1¼	67 x 56	10
5226038	1½	76 x 71	10
5226050	2"	80 x 88	10



TUSSENKLEP MET HANGENDE KLEP
INTERMEDIATE VALVE WITH HANGING VALVE
ZWISCHENVENTIL MIT HÄNGENDEM VENTIL

5228013	½
5228019	¾
5228025	1"
5228032	1¼
5228038	1½
5228050	2"



MESSING SLANG VERBINDINGSPIJPJES
BRASS CONNECTOR
MESSING SCHLAUCHVERLÄNGERUNG

Lengte / length / Länge: +/- 6 cm.

5330006	6
5330008	8
5330010	10
5330013	13
5330019	19
5330025	25
5330032	32
5330038	38



NYLON Y-STUK VOOR SLANG
NYLON Y-PIECE FOR HOSE
NYLON Y-STÜCK FÜR SCHLAUCH

nr.	∅
5332113	13
5332116	16
5332119	19



NYLON VERBINDINGSPIJP
CONNECTINGPIPE
NYLON VERLÄNGERUNG

VOOR SLANG - FOR HOSE - FÜR SCHLAUCH

nr.	∅
5331006	6
5331008	8
5331010	10
5331013	13
5331016	16
5331019	19
5331025	25



NYLON T-STUK VOOR SLANG
NYLON T-SLEAVE FOR HOSE
NYLON T-STÜCK FÜR SCHLAUCH

nr.	∅
5332006	6
5332008	8
5332010	10
5332013	13
5332016	16
5332019	19
5332025	25



AARDING AANSLUITING
VOOR GEBRUIK MET HUIDDOORVOEREN
BRASS WASHER
WITH GROUND WIRE FITTING
MESSING UNTERLEGSCHIEBE
MIT ERDUNGSANSCHLUSS

nr.	maat
5865110	⅜
5865113	½
5865119	¾
5865125	1"
5865132	1¼
5865138	1½
5865150	2"



TEFLONTAPE
TEFLON BAND

nr.	
9992218	1



VIBA
 Voor messing.

nr.		
9992212	1110 H	1
9990645	1346	1



VERDELER
MANIFOLD
VERTEILER

nr.	∅	∅
581932134	A: 1¼	B: ½



CR KOGELKRAAN BI/BI
CR BALL VALVE FEM/FEM
CR KUGELHAHN
 INNEN/INNENGEWINDE

5243010	3/8
5243013	1/2
5243019	3/4
5243025	1"
5243032	1 1/4
5243038	1 1/2
5243050	2"



MESSING KOGELKRAAN BI/BI
BRASS BALL VALVE FEM/FEM
MESSING KUGELHAHN
 INNEN/INNENGEWINDE

5550006	1/4
5550010	3/8
5550013	1/2
5550019	3/4
5550025	1"
5550032	1 1/4
5550038	1 1/2
5550050	2"
5550065	2 1/2
5550076	3"



MESSING KOGELKRAAN BI/BI
BRASS BALL VALVE MALE/FEM
MESSING KUGELHAHN
 AUSSEN/INNENGEWINDE

5251006	1/4
5251010	3/8
5251013	1/2
5251019	3/4
5251025	1"
5251032	1 1/4
5251038	1 1/2
5251050	2"



MESSING VERCHROOMDE
3-WEG KOGELKRAAN
3-WAY BALL VALVE
3-WEGE KUGELHAHN
 LICHTE UITVOERING / LIGHT VERSION

L-boring	
5280010	3/8
5280013	1/2
5280019	3/4
5280025	1"
5280032	1 1/4
5280038	1 1/2
T-boring	
5285006	1/4
5285010	3/8
5285013	1/2
5285019	3/4
5285025	1"
5285032	1 1/4
5285038	1 1/2
5285050	2"



MESSING VERCHROOMDE
3-WEG KOGELKRAAN
3-WAY BALL VALVE
3-WEGE KUGELHAHN
 ZWARE UITVOERING / HEAVY VERSION

L-boring en massieve kogel

5281013	1/2
5281019	3/4
5281025	1"
5281032	1 1/4
5281038	1 1/2
5281050	2"



KOGELKRAAN MET
VORSTBESCHERMING BI/BI
BRASS BALL VALVE WITH
FROSTPROTECTION FEM/FEM
KUGELHAHN MIT FROST-
SCHUTZ INNEN/INNEN

5248013	1/2
5248019	3/4
5248025	1"
5248032	1 1/4
5248038	1 1/2



MINI KOGELKRAAN BI/BI
MINI BALL VALVE FEM/FEM
MINI KUGELHAHN
 INNEN/INNENGEWINDE

Verchromd / chromed / verchromtes
 Temp.: - 30°C tot + 180°C
 Werkdruk/pressure: 15 bar

5241006	8	1/4
5241010	8	3/8
5241013	10	1/2



MINI KOGELKRAAN BI/BI
MINI BALL VALVE MALE/FEM
MINI KUGELHAHN
 AUSSEN/INNENGEWINDE

Verchromd / chromed / verchromtes
 Temp.: - 30 °C tot + 180 °C
 Werkdruk/pressure: 15 bar

5242006	8	1/4
5242010	8	3/8
5242013	10	1/2



SNELSLUITKRAAN BRONS
 BI/BI
QUICK CLOSING SLIDE
VALVE FEM/FEM
SCHNELL SCHLIESSEN-
DER KUGELHAHN
 INNEN/INNENGEWINDE

5577010	3/8
5577013	1/2
5577019	3/4
5577025	1"



YPSILON KRAAN
YPSILON BALL VALVE
YPSILON KUGELHAHN
 Uitlopend artikel.

5288013	1/2 x 1/2 x 3/8
5288025	1 x 3/4 x 3/4
5288032	1 1/4 x 1 x 1



A



B

PP KOGELKRAAN BI/BI
PP BALL VALVE FEM/FEM
PP KUGELHAHN INNEN/INNENGEWINDE

5620013	A	1/2
5620019	A	3/4
5620025	A	1"
5620032	B	1 1/4
5620038	B	1 1/2
5620050	B	2"



CAV BRANDSTOFFFILTER
CAV DIESELFILTER
CAV TREIBSTOFFFILTER

Diesel brandstofffilter met water-afscheider
 Complete Dieselfilter with waterdrain
 Dieselfilter mit Wasserseparator

nr.	omschrijving	
8501002	CAV 296 compleet	A
	glas / glass / Glas	
8501333	CAV 296 compleet met aluminium / Aluminium	B



LOSSE FILTER
FILTER ONLY
NUR FILTER

45 L/H 0,75/L/min

nr.	omschrijving
8500002	Filter type 296
8500012	Setje ringen Set of rings / Reihe Ringe



AANSLUITSTUKKEN BSP
BINNENDRAAD
HOSE CONNECTION
1/4 BSP THREAD
ADAPTER FÜR 1/4 BSP
GEWINDE

2 STUKS - 2 PIECES - 2 STÜCK

nr.	omschrijving
8500004	Aansluitstukken voor 1/4 BSP-binnen draad voor aansluiting met slang pilaar enz.



SLANGTULE PER STUK
DIRECT HOSE NOZZLE
SCHLAUCHANSCHLUSS

nr.	omschrijving	
8500013	A	8 mm
8500014	B	8 mm



AANSLUITSTUKKEN LEIDING
PIPE CONNECTOR
ANSCHLUSS FÜR KUPFER-LEITUNG

2 STUKS - 2 PIECES - 2 STÜCK

nr.	omschrijving
8500003	8 mm



MESSING PLUG
BRASS LOCKERNUT
MESSING BLINDSTOPF

nr.	omschrijving
8500005	Messing plug ten behoeve van de CAV brandstoffilter Delphi



PVC PLUG
PVC LOCKERNUT
PVC BLINDSTOPF

nr.	omschrijving
8500115	Pvc plug ten behoeve van de CAV brandstoffilter Delphi



VERLOOPNIPPEL
REDUCINGNIPPLE BANJO
REDUZIERNIPPEL BANJO

t.b.v. banjoubout te gebruiken bij compleet C.A.V. 296 brandstoffilter.

nr.	omschrijving
8500006	M14 x 1,5



LOS GLAS
GLASS BOWL
GLAS FÜR CAV TREIBSTOFFFILTER

nr.	omschrijving
8500008	



SEPAR FILTER & WATER-AFSCHEIDER
SEPAR FILTER & WATER-SEPARATOR
SEPAR FILTER & WASSERABSCHEIDER

5 L/min 300 L/h

nr.	mm	vpe
85032000	140 x 258	1



SEPAR FILTER & WATER-AFSCHEIDER METALEN KOM
SEPAR FILTER & WATER-SEPARATOR METAL BOWL
SEPAR FILTER & WASSERABSCHEIDER METALLBOWLE

5 L/min 300 L/h

nr.	mm	vpe
85032000M	140 x 258	1



AANSLUITSTUKKEN BSP
BINNENDRAAD
HOSE CONNECTION 3/8
BSP THREAD
ADAPTER FÜR 3/8 BSP
GEWINDE

2 STUKS - 2 PIECES - 2 STÜCK

nr.	omschrijving
8500018	Voor 3/8 BSP-binnen draad voor aansluiting met slang pilaar enz.



KNELKOPPELING 8MM
VOOR SEPAR FILTER
COUPLING 8MM FOR SEPAR FILTER
SEPAR GERADE VER-SCHRAUBUNG 10MM

nr.	maat	vpe
8502011	M16x1,5mm - 8mm	1



KNEL KOPPELING 10 MM
VOOR SEPAR FILTER
COUPLING 10MM FOR SEPAR FILTER
SEPAR GERADE VER-SCHRAUBUNG 10MM

nr.	maat	vpe
8502012	M16x1,5mm - 10mm	1



SEPAR FILTER
SEPAR FILTER ELEMENT
SEPAR FILTEREINSATZ

nr.	vpe
85032001	1



SLANGPILAAR VOOR SEPAR FILTER
HOSE CONNECTOR FOR SEPAR FILTER
SCHLAUCHTÜLLE FÜR SEPAR FILTER

nr.	maat	vpe
8502016	M16x1,5mm - 10mm with 8mm Hose Connector	1



BRANDSTOFFFILTER VOOR AUTOMOTIVE
FUEL FILTER FOR AUTOMOTIVE
KRAFTSTOFFFILTER FÜR AUTOMOTIVE

3 L/min 180 L/h

nr.	maat	vpe
85031000	116 mm x 166 mm	1



LOS FILTER 10 MICRON
FILTER ELEMENT 10 MICRON
FILTEREINSATZ 10 MICRON

nr.	maat	vpe
85031001		1



GAS FITWERK

MEERDERE GAS FITWERK OP AANVRAAG LEVERBAAR

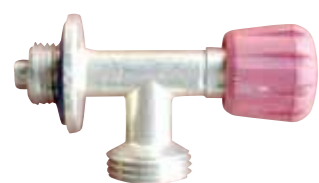

FLENSKRAAN GASBOTTLE COCK GASHAHN

(COMBI-EN CAMPINGGAS)

nr.	soort
1666248	Flenskraan haaks Flange tap angled Flanschhahn abgewinkelt



KRAAN ENKEL SHUT OFF VALVE SCHNELLSCHLUSS ABSPERRVENTIL

Snel sluitkraan voor 8 mm

nr.	soort
1666237	Enkel

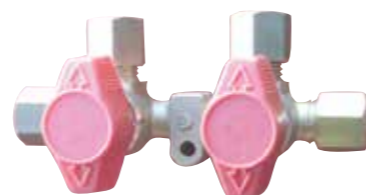

KRAAN DUBBEL SHUT OFF DOUBLE VALVE SCHNELLSCHLUSS ABSPERRVENTIL 2-FACH

WITH FIXING PLATE / MIT MONTAGEPLATTE

Snel sluitkraan voor 8 mm

nr.	soort
1666239	Dubbel

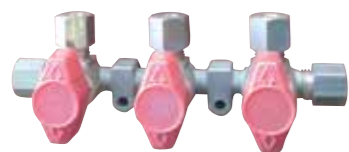

KRAAN 3-DUBBEL SHUT OFF VALVE 3-WAY ABFANGHAHN DREI

WITH FIXING PLATE / MIT MONTAGEPLATTE

Snel sluitkraan voor 8 mm

nr.	soort
1666240	3- Dubbel



KLEPAFSLUITER 12VDC GLOBE VALVE ABSPERRVENTIL

ELECTRISCH / ELECTRONIC
ELEKTRONISCH

2x rechte knel koppeling 8 x 1/4

nr.	soort
991666136	12vdc



DRUKREGELAAR MET AFBLASVENTIEL PRESSURE REGULATOR WITH BLOW-OFF VALVE DRUCKREELER MIT AB- BLASVENTIL

Voor caravan of camper

nr.	soort
1666656	30 mbar
1666656-50	50 mbar
1666662	manometer, 30 mbar
1666663	manometer, 50 mbar
1666738	Haaks model, 50mbar
1666749	Haaks model met mamometer, 50 mbar



DRUKREGELAAR PRESSURE REGULATOR DRUCKREGLER

Tbv de watersport

nr.	soort	
1666744	Haaks model	30 mbar
1666440	Recht model	30 mbar



DRUKREGELAAR PRESSURE REGULATOR DRUCKREGLER

MET/WITH/MIT MANOMETER

Tbv de watersport

nr.	soort	
1666743	Haaks model	30 mbar
1666442	Recht model	30 mbar



KOPPELING COUPLING STRAIGHT KUPPLUNG GERADE

nr.	soort	maat in mm
1666801	Rechte koppeling	2 x 8

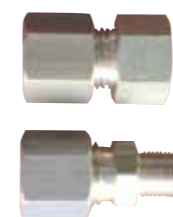

KOPPELING COUPLING FOR COPPERPIPE 8 MM KUPPLUNG FÜR KUPFERROHR

A	nr.	B	mm
	1666810	B	8 x 1/8
	1666811	B	8 x 1/4
	1666812	B	8 x 3/8
B	1666816	A	8 x 3/8



EINDSTOP BLIND LOCKERNUT FOR COPPERPIPE BLINDSTOPF FÜR KUPFERROHR

nr.	maat in mm
1666820	8 mm



T-STUK T-CONNECTOR T-STÜCK FÜR KUPFERROHR

nr.	mm
1666823	3 x 8 mm



KNIE KOPPELING ELBOW JOINT 2X COPPERPIPE WINKELANSCHLUSS 2X KUPFERROHR

nr.	maat in mm
1666827	2 x 8 mm



KNIE KOPPELING ELBOW JOINT WINKELANSCHLUSS

nr.	maat in mm
1666832	uitw. 8 x 1/4



SCHOT KOPPELING BULKHEAD SCHOTTENWAND DURCHGANG

nr.	mm
1666834	2 x 8 mm

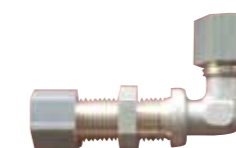

SCHOT KOPPELING HAAKS BULKHEAD ELBOW SCHOTTENWAND WINKEL

nr.	mm
1666837	2 x 8 mm



SCHOT KOPPELING BULKHEAD 1/4 THREADED RH SCHOTTENWAND KUPPLUNG

nr.	mm
1666414	1/4 links bu.dr. x 8 mm knel



**SLANGPILAAR
HOSE TAIL
GASSCHLAUCHTÜLLE**

8 mm knel, 8 mm, 8 mm Rohr mit
Schneidring

nr.
1666332



**SLANGPILAAR OP GRONDPLAAT
HOSETAIL ON BASEPLATE
GASSCHLAUCHTÜLLE MIT
MONTAGEPLAATJE UND SCHNEIDRING**

nr.
1666331 Rechte kop. 8 mm knel x
slangpilaar op grondplaat

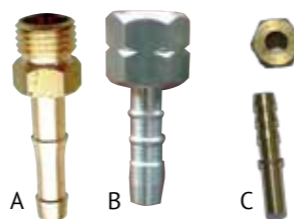

**SLANGPILAAR
HOSETAIL
GASSCHLAUCHTÜLLE**

nr.
1666429 A Slangpilaar metrisch
¼ x 1,5 uitwendig
1666413 B Slangpilaar bi.dr. ¼
links inwendig wartel
1666412 C Links inwendig wartel
gat M8



**KLEM-SLANGPILAAR GLAD
HOSETAIL SMOOTH
GASSCHLAUCHTÜLLE
GLATT**

nr. mm
1666294 8

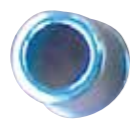

**RVS HULS 16 MM
STAINLESS STEEL SLEEVE
FOR GAS HOSE
EDELSTAHLHÜLSE FÜR
GASSCHLAUCH**

nr.
1666000 16 mm t.b.v. propaangaslang



**MUURBEUGEL
WALL BRACKET
WANDHALTERUNG**

nr.
1666238 voor/for/fur 1666237



**KOPEREN LEIDING
COPPER PIPE FOR LIQUID
GAS IN FLOW
KUPFERLEITUNG FÜR
FLÜSSIGGAS**

6 X 8 MM
nr.
1666402 50 mtr

Op gewenste lengte te leveren met
toeslag.

Can also be delivered in desired length
with surcharge.

Gegen Aufpreis in der gewünschten
Länge lieferbar.



**LOSSE KNELRINGEN
SPARE OGIVE
ERSATZTEILE FÜR KLEMMFITTINGE**

nr.
1666003 A Eindstop knelkoppeling / endstop compression ring /
Endanschlag Klemmverbindung
8 mm
1666281 B Duitse knelring konisch / German conical compression / Deutsche Konus
8 mm
1666306 C Konische knelring/conical compression ring / Konus für Mutter
1666727 D Verstevigingsbus/reinforcement sleeve/Verstärkungshülse: 8 mm

GEPERSTE GASSLANGEN GASINSTALLATION HOSES GASSCHLÄUCHE



glad / smooth / glatt

nr. soort
991666001 verL.slang 60 cm 8mm knel x 8mm
991666002 verL.slang 80 cm 8mm knel x 8mm
991666016 verL.slang 100 cm 8mm knel x 8mm



nr. soort
991666010 verL.slang 60 cm 2x 1/4 li.wartel
991666011 verL.slang 80 cm 2x 1/4 li.wartel
991666012 verL.slang 100 cm 2x 1/4 li.wartel



glad / smooth / glatt

nr. soort
991666004 verL.slang 60 cm 1/4 li.wartel x 8mm
991666005 verL.slang 80 cm 1/4 li.wartel x 8mm
991666006 verL.slang 100 cm 1/4 li.wartel x 8mm



nr. soort
991666013 verL.slang 60 cm 2 x 8 mm knel
991666014 verL.slang 80 cm 2 x 8 mm knel
991666015 verL.slang 100 cm 2 x 8 mm knel



nr. soort
991666007 verL.slang 60 cm 1/4 li.wartel x 8mm knel
991666008 verL.slang 80 cm 1/4 li.wartel x 8mm knel
991666009 verL.slang 100 cm 1/4 li.wartel x 8mm knel



2x glad / 2x smooth / 2x glatt
nr. soort
991666032 verL.slang 60 cm 2 x 8 mm
991666035 verL.slang 80 cm 2 x 8 mm
991666022 verL.slang 100 cm 2 x 8 mm

CLASS 2-8 MM-10 BAR-PROPANE/BUTANE

**PROPAANGASSLANG
GASINSTALLATION HOSE
GASSCHLAUCH**

NEN-EN 16436-1

nr. inw./uitw. rollengte
3265008.2 8/15 50 meter



HEP20



**HEP20 PB BUIS OP ROL
DIFFUSIE DICHT**
**HEP20 BARRIER PIPE
DIFFUSION TIGHT**
**HEP20 ROHR AUF ROLLE
DIFFUSIONSDICHT**

nr.	lengte	maat
156309DD	50 meter	15
156311DD	50 meter	22



**RECHTE KOPPELING
2X INSTEK (HD1)**
STRAIGHT CONNECTOR
GERADE KUPPLUNG

nr.	maat
156100	15 x 15
156101	22 x 22



**VERLOOPSTUK SPIE X
INSTEK (HD2)**
REDUCE > SPIGOT
REDUZIERSTÜCK

nr.	maat
156105	22 x 15



**STRANGAFTAPPER (HX32)
DRAINCOCK
VENTIL/ABFLUSS**

nr.	maat
156175	15



**SCHROEFSTUK
BUITENDRAAD X INSTEK
(HX29)**
**BRASS ADAPTER MALE
ADAPTER AUSSENGEWINDE/STECK**

nr.	maat
156162	1/2" x 15
156163	3/4" x 22



**SCHROEFBUS
BINNENDRAAD X INSTEK
(HX28)**
**BRASS ADAPTER FEMALE
ADAPTER INNENGEWINDE/STECK**

nr.	maat
156168	1/2" x 15
156168B	3/4" x 15
156169	3/4" x 22



**KNIE 90°C
2X INSTEK (HD5)**
**ELBOW
WINKEL**

nr.	maat
156110	15 x 15
156111	22 x 22



**T-STUK 3X INSTEK
(HD10)**
**EQUAL TEE
T-STÜCK**

nr.	maat
156115	15 x 15 x 15
156116	22 x 22 x 22



**VERLOOP T-STUK 3X
INSTEK (HD12/HD13/HD14)**
**REDUCE TEE
REDUZIER T-STÜCK**

nr.	maat
156122	22 x 15 x 15
156121	22 x 15 x 22
156120	22 x 22 x 15



**KNIE INSTEK X
BUITENDRAAD**
**ELBOW > MALE THREAD
WINKEL AUSSENGEWINDE**

nr.	maat
156265	15 x 1/2"
156266	22 x 3/4"



**KNIE INSTEK X
BINNENDRAAD**
**ELBOUW > FEMALE THREAD
WINKEL INNENGEWINDE**

nr.	maat
156260	15 x 1/2"
156261	22 x 3/4"



**STEUNBUS (HX60)
SMARTSLEEVE PIPE
SUPPORT
VERSTÄRKUNGSHÜLSE**

nr.	verp.eenheid	maat
156210	50	15
156211	50	22



**MUURPLAATKOPPELING
BINNENDRAAD
X INSTEK (HX8)**
**WALL PLATE CLAMP
FEMALE/PUSH-FIT
WANDMONTAGE EINHEIT
INNENGEWINDE/STECK**

nr.	maat
156275	1/2" bi.dr.x 15



**AANSLUITSTUK
BINNENDRAAD
X SPIE (HX30)**
**BRASS ADAPTER FEMALE
ROHRTÜLLE INNEN-
GEWINDE**

nr.	maat
156165	1/2" BSP x 15
156166	3/4" BSP x 22



**AANSLUITSTUK
BUITENDRAAD
X SPIE (HX31)**
**BRASS ADAPTER MALE
ROHRTÜLLE AUSSEN-
GEWINDE**

nr.	maat
156170	1/2" BSP x 15
156171	3/4" BSP x 22



**PIJPBEUGEL MET
GAT 5 MM (HX85)**
**PIPECLIPS SCREWTYPE
ROHRCLIP MIT
SCHRAUBENLOCH**

nr.	verp.eenheid	maat
156215	50	15
156216	50	22



**MS T-STUK 2 X INSTEK X
BINNENDRAAD**
**BRASS TEE
T-STÜCK 1 X INNEN-
GEWINDE/2 X STECK**

nr.	maat
156385	15 x 1/2" x 15



**PIJPENSNIJDER
PIPECUTTER SCISSOR
ROHRSCHEIDER**

nr.	maat
156225	Ø10 - Ø 28



**RECHTE OVERGANGS-
KOPPELING INSTEEL X
WARTEL. (HX25)**
ADAPTER
GERADE KUPPLUNG
 STECK/INNENGEWINDE

nr.	maat
156150	15 x 1/2"
156151	15 x 3/4"



**TANKDOORVOER INSTEEL
X BUITENDRAAD (HX20)**
TANK CONNECTOR
TANKVERSCHRAUBUNG
 STECK/AUSSENGEWINDE

nr.	maat
156140	15 x 1/2"



**MUURPLAATKOPPELING
(HX6)**
WALLPLATE ELBOW
WANDSCHEIBE

nr.	maat
156113	15 x 1/2"



BITITE EINDKAP (HX44)
ENDCAP
ENDKAPPE

nr.	maat
156004	15
156008	22



**KLEMSTUK VOOR
KOUDBUIGEN. (HX75)**
**COLDFORMING
BENDFIXTURE**
**KALTUMFORMENDE
ROHRBIEGESTÜTZ**

nr.	maat
156230	15
156231	22



**BITITE™ DEMONTAGE
WIG (HX79)**
HEPKEY
**HEPKEY DEMONTAGE-
WERKZEUG**

nr.	maat
156014	15
156018	22

EXPANSIETANK
EXPANSION TANK
AKKUMULATOR



Ideale aanvulling op een waterpomp. Een drukvat houdt de leidingen onder druk. Het interne membraam vangt stoten op en laat een regelmatige waterstroom door. Verlengt de levensduur van de waterpomp. Standaard ingesteld op 0,9 bar (13,05 psi). De druk kan worden aangepast.

 Ideal addition to a water pump. An expansion tank keeps the pipes/hoses under pressure. The internal membrane absorbs impacts and therefore shows a regular water flow. This extends the life of the pump. The pressure can be adjusted. By default set to 0.9 bar.

 Ideale Ergänzung zu einer Wasserpumpe. Ein Druckbehälter hält die Rohre/Schläuche unter Druck. Die innere Membran absorbiert Stöße und zeigt daher einen regelmäßigen Wasserfluss. Verlängert die Lebensdauer der Pumpe. Der Druck kann eingestellt werden. Standardmäßig auf 0,9 bar eingestellt.

nr.	inhoud
156789	0,6 liter



**AFSLUITKRAAN 2X
INSTEEL (HX37C/ HX38C)**
STOPCOCK
**ABSCHLUSSHAHN
2 X STECK**

Universeel voor koud en warm water.
 For cold and warm water.
 Geeignet für Kalt- und Warmwasser

nr.	maat
156134	15



CONNECT TO BETTER

Wavin Hep20

push-fit leidingsysteem
voor warm en koud water



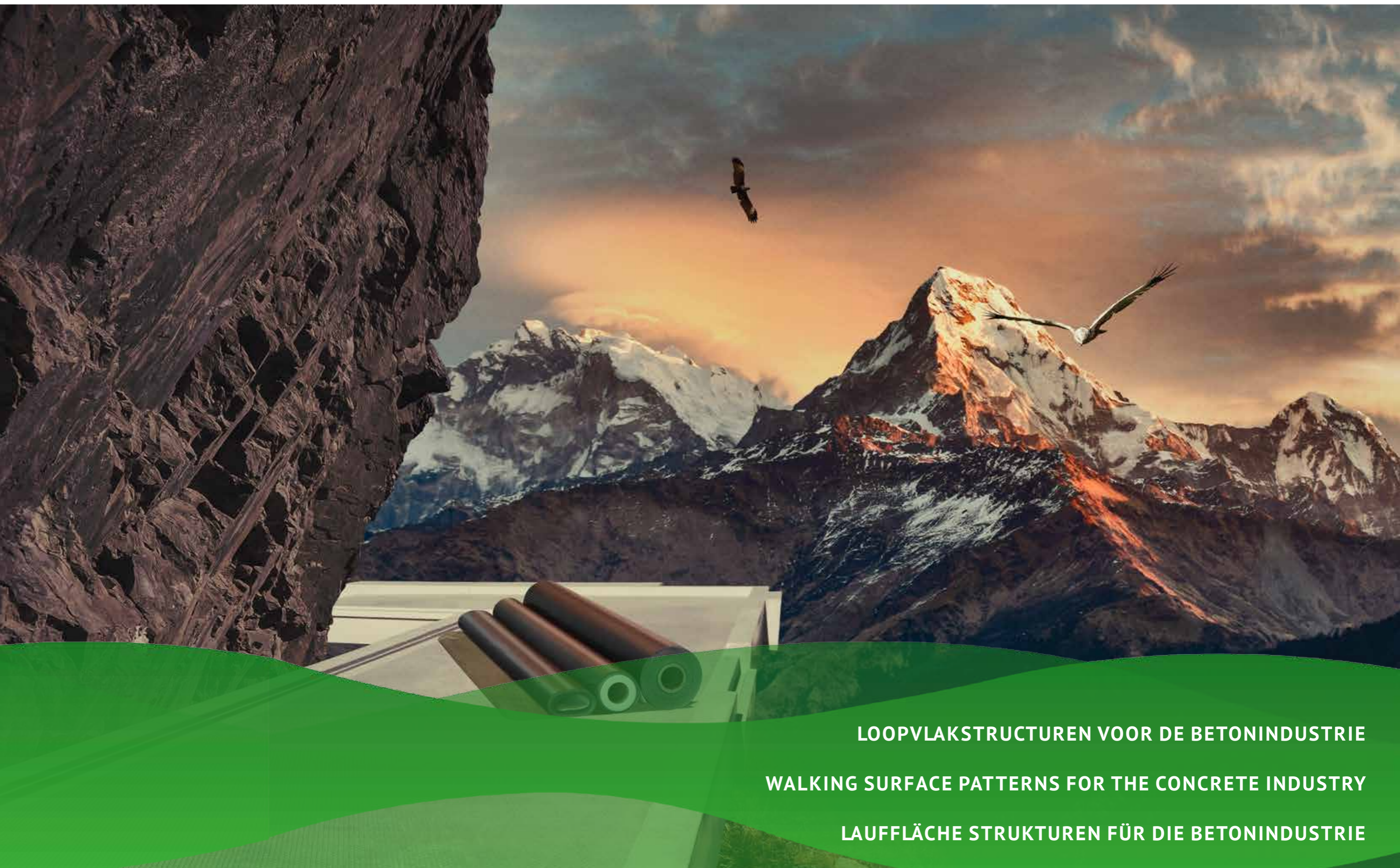

LOOPVLAKSTRUCTUREN VOOR DE BETONINDUSTRIE
WALKING SURFACE PATTERNS FOR THE CONCRETE INDUSTRY
LAUFLÄCHE STRUKTUREN FÜR DIE BETONINDUSTRIE

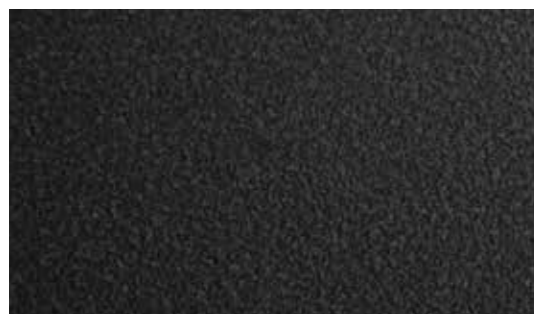

ZAND

De zand structuur is leverbaar in verschillende maten:

Rollbreedte	: 2 meter uit voorraad leverbaar
	: 3 meter uit voorraad leverbaar
Rollengte	: 52 m ¹
Rol oppervlakte	: 104 m ² of 156 m ²

nr.	omschrijving
8844440	Zand profiel met doek 2 meter
8844442	Zand profiel met doek 3 meter

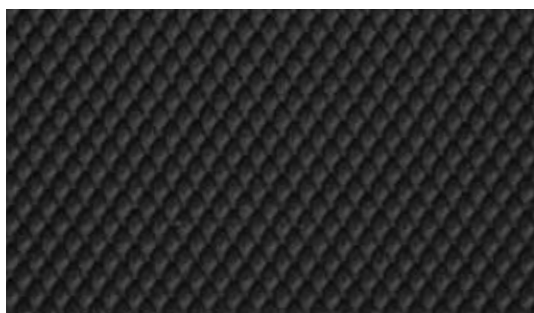

PYRAMIDE (GOLF)

De pyramide structuur is leverbaar in de volgende maten:

Rollbreedte	: 2 meter uit voorraad leverbaar
Rollengte	: 52 m ¹
Rol oppervlakte	: 104 m ²

nr.	omschrijving
8844430	Pyramide profiel met doek
8844432	Pyramide profiel met gladde onderlaag

DG STRUCTUURLIJM

DG structuurlijm is uitsluitend bestemd voor de verwerking van de diverse DG beton structuurmatten op blijvend niet afgesloten (niet ademende) ondergronden.

nr.	omschrijving
8844455	10 liter emmer, goed voor ca. 40m ² structuurmat



GAAS (MANDJES)

De gaas structuur is leverbaar in de volgende maten:

Rollbreedte	: 2 meter uit voorraad leverbaar
	: 3 meter uit voorraad leverbaar
Rollengte	: 52 m ¹
Rol oppervlakte	: 104 m ² of 156 m ²

nr.	omschrijving
8844450	Gaas profiel met doek 2 meter
8844452	Gaas profiel met doek 3 meter



GLAD

De gladde structuur is leverbaar in de volgende maten:

Rollbreedte	: 2 meter op aanvraag leverbaar
	: 3 meter op aanvraag leverbaar.
Rollengte	: 52 m ¹
Rol oppervlakte	: 104 m ² of 156 m ²

nr.	omschrijving
8844460	Gladprofiel met doek



ZIE VOOR CELRUBBER BLADZIJDE 53

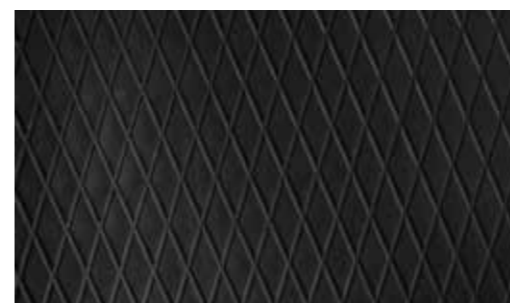

WIEBER KLEIN

De wieber structuur is leverbaar in de volgende maten:

Rollbreedte	: 2 en 3 meter uit voorraad leverbaar
Rollengte	: 52 m ¹
Rol oppervlakte	: 104 m ² of 156 m ²

nr.	omschrijving
8844420	Wieber klein met doek 2 meter breed
8844422	Wieber klein met doek 3 meter breed
8844419	Wieber klein met gladde onderlaag 3 meter breed



BLOKJES KLEIN

De blokjes structuur is leverbaar in de volgende maten:

Rollbreedte	: 2 meter uit voorraad leverbaar
	: 3 meter uit voorraad leverbaar
Rollengte	: 52 m ¹
Rol oppervlakte	: 104 m ² of 156 m ²

nr.	omschrijving
8844470	Blokjes profiel 2 meter breed, 12 x 12
8844471	Blokjes profiel 3 meter breed, 12 x 12



SCAN DE QR-CODE OM DE LOOPVLAKSTRUCTUURMATTEN METEEN TE GEBRUIKEN IN HET BESTEK

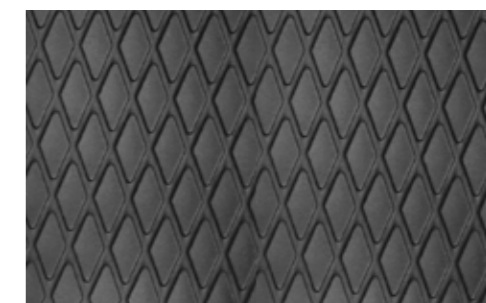

WIEBER GROOT

De wieber structuur is leverbaar in de volgende maten:

Rollbreedte	: 2 en 3 meter uit voorraad leverbaar
Rollengte	: 52 m ¹
Rol oppervlakte	: 104 m ² of 156 m ²

nr.	omschrijving
8844477	Wieber groot met doek 2 meter breed
8844478	Wieber groot met doek 3 meter breed
8844479	Wieber groot met gladde onderlaag 3 meter breed

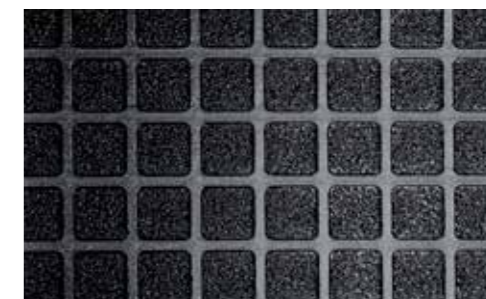

BLOKJES GROOT

De blokjes structuur is leverbaar in de volgende maten:

Rollbreedte	: 2 meter uit voorraad leverbaar
	: 3 meter uit voorraad leverbaar
Rollengte	: 52 m ¹
Rol oppervlakte	: 104 m ² of 156 m ²

nr.	omschrijving
8844487	Blokjes profiel 2 meter breed, 14,5 x 14,5
8844488	Blokjes profiel 3 meter breed, 14,5 x 14,5



**ALGEMENE VOORWAARDEN
TERMS AND CONDITIONS**

BIJZONDERE LEVERINGS-EN BETALINGSVOORWAARDEN

Alle prijzen zijn exclusief BTW, inclusief normale verpakking en gelden voor levering franco Nederlandse bestemming. Echter voor zendingen met een waarde minder dan € 495,00 (exclusief BTW), zal een bijdrage in de vrachtkosten in rekening worden gebracht. Dit is afhankelijk van het gewicht van de goederen en/of aantal colli.

Betaling

Binnen 30 dagen na factuurdatum strikt netto.

Bij opgehaalde goederen met een waarde van onder de €100,00 dient men contant te betalen.

Automatische incasso

Wij hebben de mogelijkheid tot automatisch incasso.

Export

De vrachtkosten van goederen buiten Nederland zijn altijd voor rekening van de klant.

Bank

Rabobank Nijkerk
IBAN: NL74RABO0377813044
BIC code/Swift adres: RABONL2U
BTW Nummer: NL813602774B01
K.v.K nr.: 08057144

Levering geschiedde volgens onze algemene leverings- en betalingsvoorwaarde, die vermeld staan op de laatste twee bladzijde van deze documentatie en gedeponereerd zijn bij de KVK te Eemland onder nr. 08057144.

ALGEMENE VOORWAARDEN DG RUBBER HOLLAND BV., GEVESTIGD TE NIJKERK

Artikel 1 Definities

Verkoper: DG Rubber Holland BV., de gebruiker van de algemene voorwaarden
Koper: de wederpartij van verkoper, de afnemer; de opdrachtgever
Overeenkomst: de overeenkomst tussen verkoper en koper.

Artikel 2 Algemeen

- 2.1 De bepalingen van deze algemene voorwaarden gelden voor iedere aanbieder en overeenkomst tussen verkoper en koper waarop verkoper deze voorwaarden van toepassing heeft verklaard, voor zover van deze voorwaarden niet door partijen uitdrukkelijk en schriftelijk is afgeweken;
- 2.2 De onderhavige algemene voorwaarden zijn eveneens van toepassing op alle overeenkomsten met verkoper, voor de uitvoering waarvan door verkoper van de diensten van derden gebruik wordt gemaakt;
- 2.3 De toepasselijkheid van algemene voorwaarden van koper wordt uitdrukkelijk uitgesloten, tenzij partijen schriftelijk anders zijn overeengekomen. Indien de algemene voorwaarden van partijen naast elkaar van toepassing zijn geldt, dat in geval dat bepalingen in de algemene voorwaarden van verkoper en koper strijdig zijn de bepalingen in de algemene voorwaarden van verkoper prevaleren;
- 2.4 Indien een of meerdere bepalingen in deze algemene voorwaarden nietig zijn of vernietigd mochten worden, blijven de overige bepalingen van deze algemene voorwaarden van toepassing. Verkoper en koper zullen nieuwe bepalingen ter vervanging van de nietige of vernietigde bepalingen overeenkomen, waarbij het doel en de strekking van de oorspronkelijke bepalingen in acht worden genomen.

Artikel 3 Aanbiedingen/Offertes/Prijzen

- 3.1 Alle aanbiedingen, in welke vorm ook, zijn vrijblijvend, tenzij in het aanbod een termijn voor aanvaarding is genoemd;
- 3.2 De door verkoper gemaakte offertes zijn vrijblijvend, tenzij anders aangegeven. Verkoper is slechts aan de offertes gebonden, indien de aanvaarding hiervan door koper schriftelijk binnen 14 dagen wordt bevestigd en op voorwaarde dat de in de offerte aangeboden materialen nog aanwezig zijn

c.q. leverbaar zijn;

- 3.3 Indien een natuurlijk persoon namens of voor rekening van een andere natuurlijk persoon een overeenkomst sluit, verklaart hij - door ondertekening van het contract - daartoe bevoegd te zijn. Deze persoon is naast de andere natuurlijke persoon hoofdelijk aansprakelijk voor alle uit de overeenkomst voortvloeiende verplichtingen;
- 3.4 Indien de aanvaarding afwijkt van het in de offerte opgenomen aanbod, is verkoper daaraan niet gebonden. De overeenkomst komt dan niet overeenkomstig deze afwijkende aanvaarding tot stand, tenzij verkoper anders aangeeft;
- 3.5 Een samengestelde prijsopgave verplicht verkoper niet tot levering van een deel van de in de aanbieding of offerte begrepen zaken tegen een overeenkomstig deel van de opgegeven prijs;
- 3.6 Aanbiedingen of offertes gelden niet voor nabestellingen;
- 3.7 Levertijden in offertes van verkoper zijn indicatief en geven koper bij overschrijding geen recht op ontbinding of schadevergoeding, ten zij uitdrukkelijk anders is overeengekomen;
- 3.8 Overeenkomsten waarbij verkoper partij is, gelden eerst als gesloten nadat verkoper schriftelijk een order van koper heeft aanvaard c.q. de feitelijke levering af magazijn van de verkochte goederen door verkoper aan koper;
- 3.9 De prijzen in de aanbiedingen/ offertes gelden voor levering af magazijn, in Euro, inclusief inladingskosten, exclusief BTW, heffingen van overheidswege, verzend-, vracht- en administratiekosten, tenzij uitdrukkelijk anders is overeengekomen;
- 3.10 Verkoper mag prijsstijgingen van meer dan 10% doorberekenen, indien zich het moment van aanbidding/ aanvaarding en levering prijswijzigingen hebben voorgedaan ten aanzien van bijvoorbeeld wisselkoersen, lonen, grondstoffen, halffabrikaten of verpakkingsmateriaal;
- 3.11 Indien verkoper met koper meer dan eenmaal overeenkomsten sluit, gelden terzake alle volgende overeenkomsten steeds de onderhavige algemene voorwaarden, ongeacht of deze al dan niet expliciet toepasselijk zijn verklaard.

Artikel 4 Levering

- 4.1 Levering geschiedt af magazijn van verkoper, tenzij partijen anders overeenkomen;
- 4.2 Koper is verplicht de zaken af te nemen op het

moment dat verkoper deze bij hem aflevert of doet afleveren, dan wel op het moment waarop deze hem volgens de overeenkomst ter beschikking worden gesteld;

- 4.3 Indien koper afname weigert of nalatig is met het verstrekken van informatie of instructies die noodzakelijk zijn voor de levering, is verkoper gerechtigd de zaken op te slaan voor rekening en risico van koper;
- 4.4 Indien geleverd wordt onder rembours, brengt verkoper steeds reboeurskosten in rekening bij koper;
- 4.5 Indien de zaken worden bezorgd is verkoper gerechtigd eventuele bezorgkosten in rekening te brengen. Franco leveringen voor orders vanaf € 450,00 ex.BTW. Bij export zijn de transportkosten voor rekening van de koper;
- 4.6 Het gewicht van de goederen bepaalt de hoogte van de vrachtkosten en deze worden apart in rekening gebracht;
- 4.7 Indien verkoper een termijn voor levering heeft opgegeven, is deze indicatief. Een opgegeven levertijd is dan ook nimmer een fatale termijn. Bij overschrijding van een termijn dient koper verkoper schriftelijk in gebreke te stellen;
- 4.8 Indien verkoper gegevens behoeft van koper in het kader van uitvoering van de overeenkomst, vangt de levertijd aan nadat koper deze aan verkoper ter beschikking heeft gesteld;
- 4.9 Verkoper is gerechtigd de zaken in gedeelten te leveren. Verkoper is gerechtigd deelleningen afzonderlijk te factureren.

Artikel 5 Onderzoek, reclames

- 5.1 Koper is gehouden het geleverde op het moment van (af)levering, doch in ieder geval binnen zo kort mogelijke termijn, te (doen) onderzoeken. Daarbij behoort koper te onderzoeken of kwaliteit en kwantiteit van het geleverde overeenstemmen met hetgeen is overeengekomen;
- 5.2 Is aan koper een model getoond, dan wordt het vermoed slechts als aanduiding te zijn getoond zonder dat de zaak daaraan behoefde te beantwoorden, tenzij uitdrukkelijk wordt overeengekomen dat de zaak daarmee zal overeenstemmen;
- 5.3 Eventuele zichtbare tekorten behoren binnen 8 werkdagen na levering schriftelijk aan verkoper te worden gemeld;
- 5.4 Koper dient verkoper in de gelegenheid te stellen de klacht te onderzoeken;

- 5.5 Indien ingevolge het vorige lid tijdig wordt gereclameerd, blijft koper verplicht tot afname en betaling van de gekochte zaken. Wenst koper gebrekkige zaken te retourneren, dan geschiedt zulks met voorafgaande schriftelijke toestemming van verkoper op de wijze zoals door verkoper aangegeven.

Artikel 6 Betaling

- 6.1 Betaling bij orders onder de € 100,00 dient te geschieden contant bij levering, overige betalingen binnen 30 dagen na factuurdatum op een door verkoper aan te geven wijze in euro's. Betaling van orders boven de € 5000,00 dient als volgt plaats te vinden:
- 1/3 bij opdracht;
- 1/3 wanneer de goederen ter verzending bij verkoper gereed liggen;
- 1/3 binnen 1 maand nadat de 2e termijnbetaling is verricht;
- 6.2 Bezwaren tegen de hoogte van de facturen schorten de betalingsverplichting niet op;
- 6.3 Indien koper in gebreke blijft in de betaling binnen de termijn van 30 dagen, is koper van rechtswege in verzuim. Koper is alsdan een rente verschuldigd van 1% per maand of gedeelte daarvan, tenzij de wettelijke rente c.q. de wettelijke handelsrente hoger is, in welk geval de hoogste rente geldt. De rente over het opeisbare bedrag zal worden berekend vanaf het moment dat koper in verzuim is tot het moment van voldoening van het volledige bedrag;
- 6.4 In geval van liquidatie, (aanvraag van) faillissement, toelating van koper tot de wettelijke schuldsanering uit hoofde van de Wet Schuldsanering Natuurlijke Personen, beslag of (voorlopige) surséance van betaling van koper zijn de vorderingen van verkoper op koper onmiddellijk opeisbaar;
- 6.5 Betalingen strekken in de eerste plaats in mindering van de kosten, vervolgens in mindering van de opengevallen rente en tenslotte in mindering van de hoofdsom en de lopende rente.
- 6.6 Het recht van koper om zijn vorderingen op verkoper te verrekenen is uitgesloten.

Artikel 7 Incassokosten

- 7.1 Indien koper in gebreke of in verzuim is in de (tijdige) nakoming van zijn verplichtingen, komen alle redelijke kosten ter verkrijging van voldoening buiten rechte voor rekening van koper. De incassokosten worden berekend overeenkomstig het incassotarif zoals door de Nederlandse Orde van Advocaten in incasso-zaken wordt geadviseerd;
- 7.2 Indien gebruiker hogere kosten heeft gemaakt, welke redelijkerwijs noodzakelijk waren, komen ook deze voor vergoeding in aanmerking;
- 7.3 De eventuele gemaakte redelijke gerechtelijke en executiekosten komen eveneens voor rekening van koper.

Artikel 8 Eigendomsvoorbehoud

- 8.1 Alle door de koper geleverde zaken blijven eigendom van verkoper totdat koper alle verplichtingen uit alle met verkoper gesloten overeenkomsten is nagekomen;
- 8.2 Koper is niet bevoegd de onder het eigendomsvoorbehoud vallende zaken te verpanden noch op enige andere wijze te bezwaren;
- 8.3 Indien derden beslag leggen op de onder eigendomsvoorbehoud geleverde zaken dan wel rechten daarop willen vestigen of doen gelden, is koper verplicht verkoper zo snel mogelijk daarvan op de hoogte te stellen;
- 8.4 Door verkoper geleverde zaken, die krachtens het eerste lid van dit artikel onder het eigendomsvoorbehoud vallen, mogen slechts in het kader van een normale bedrijfsuitoefening worden doorverkocht en nimmer als betaalmiddel worden gebruikt;
- 8.5 Voor het geval dat verkoper zijn in dit artikel aangeduide eigendomsrechten wil uitoefenen, geeft koper reeds nu onvoorwaardelijke en niet herroepbare toestemming aan verkoper

of door deze aan te wijzen derden om al die plaatsen te betreden waar de eigendommen van verkoper zich bevinden en die zaken mede terug te nemen.

Artikel 9 Garantie

- 9.1 De door verkoper geleverde zaken voldoen aan de technische eisen en specificaties welke door de Nederlandse wetgeving worden gesteld;
- 9.2 De in het eerste lid van dit artikel genoemde garantie geldt gedurende een periode van 6 maanden na levering;
- 9.3 Deze garantie is beperkt tot:
- fabrieksfouten en omvat dus geen schade ten gevolge van slijtage en oneigenlijk c.q. ondeskundig gebruik;
- leveringen aan kopers in Nederland;
- 9.4 Deze garantie vervalt:
- bij doorverkoop van de geleverde zaken, tenzij partijen uitdrukkelijk anders zijn overeengekomen;
- bij onoordeelkundig of oneigenlijk gebruik door koper of een derde of na wijzigingen, veranderingen of reparatie door koper of een derde aan of van het geleverde;
- 9.5 Zolang koper niet aan zijn verplichtingen voortvloeiende uit de door partijen gesloten overeenkomsten heeft voldaan, kan hij geen beroep doen op garantie.

Artikel 10 Opschorting en ontbinding

- 10.1 Verkoper is bevoegd de nakoming van zijn verplichtingen op te schorten of de overeenkomst te ontbinden, indien:
* koper zijn verplichtingen uit de overeenkomst niet, niet tijdig of niet volledig nakomt;
*na het sluiten van de overeenkomst verkoper ter kennis gekomen omstandigheden goede grond geven te vrezen dat koper de verplichtingen niet, niet tijdig of niet volledig zal nakomen. In geval er goede grond bestaat te vrezen dat koper slechts gedeeltelijk of niet behoorlijk zal nakomen, is de opschorting slechts toegelaten voor zover de tekortkoming dit rechtvaardigt;
* koper bij het sluiten van de overeenkomst verzocht is zekerheid te stellen voor de voldoening van zijn verplichtingen uit de overeenkomst en deze zekerheid uitblijft of onvoldoende is. Zodra zekerheid is gesteld, vervalt de bevoegdheid tot opschorting, tenzij deze voldoening daardoor onredelijk is vertraagd;
- 10.2 Voorts is verkoper bevoegd de overeenkomst te (doen) ontbinden, indien zich omstandigheden voordoen welke van dien aard zijn dat nakoming van de overeenkomst onmogelijk of naar maatstaven van redelijkheid en billijkheid niet langer kan worden gevergd dan wel indien zich anderszins omstandigheden voordoen welke van dien aard zijn dat ongewijzigde instandhouding van de overeenkomst in redelijkheid niet mag worden verwacht;
- 10.3 Indien de overeenkomst wordt ontbonden, zijn de vorderingen van verkoper op koper onmiddellijk opeisbaar. Indien verkoper de nakoming van de verplichtingen opschort, behoudt hij zijn aanspraken uit de wet en overeenkomst;
- 10.4 Verkoper behoudt steeds het recht schadevergoeding te vorderen.

Artikel 11 Annulering

- 11.1 Indien koper, nadat een overeenkomst met verkoper tot stand is gekomen, deze wenst te annuleren, wordt 10% van de overerenkomsten orderprijs inclusief BTW als annuleringskosten bij koper in rekening gebracht, onverminderd het recht op volledige schadevergoeding, inclusief gederfde winst;
- 11.2 Indien koper bij annulering de afname weigert van de reeds door verkoper aangeschafte zaken zoals materialen en grondstoffen, al dan niet be- of verwerkt, is koper gehouden alle hieruit voortvloeiende kosten aan verkoper te voldoen.

Artikel 12 Aansprakelijkheid

- 12.1 Indien door verkoper geleverde zaken gebrekkig

zijn, is de aansprakelijkheid van verkoper jegens koper beperkt tot hetgeen in deze voorwaarden onder "Garantie" is geregeld;

12.2 Indien verkoper aansprakelijk is voor directe schade, dan is die aansprakelijkheid beperkt tot maximaal het bedrag van de door de assuradeur van verkoper te verstrekken uitkering, althans tot maximaal het factuurbedrag, althans dat gedeelte van de overeenkomst waarop de aansprakelijkheid betrekking heeft;

12.3 Verkoper is nimmer aansprakelijk voor indirecte schade, daaronder begrepen gevolgschade, gederfde winst, gemiste besparingen en schade door bedrijfsstagnatie;

12.4 De in deze voorwaarden opgenomen beperkingen van de aansprakelijkheid voor directe schade gelden niet indien de schade te wijten is aan opzet of grove schuld van verkoper of zijn ondergeschikten.

Artikel 13 Risico-overgang

- 13.1 Het risico van verlies of beschadiging van de producten die voorwerp van de overeenkomst zijn, gaat op koper over op het moment waarop deze producten aan koper juridisch en/of feitelijk worden geleverd en daarmee in de macht van koper of van een door koper aan te wijzen derde worden gebracht;
- 13.2 Indien verkoper voor transport zorgdraagt, geschiedt dit geheel op risico van koper.

Artikel 14 Overmacht

- 14.1 Partijen zijn niet gehouden tot het nakomen van enige verplichting, indien zij daartoe gehinderd worden als gevolg van een omstandigheid die niet is te wijten aan grove schuld of opzet aan de zijde van de partij die zich daarop beroept, en noch krachtens de wet, een rechtshandeling of in het verkeer geldende opvattingen voor hun rekening komt;
- 14.2 Onder overmacht wordt in deze algemene voorwaarden verstaan naast hetgeen daaromtrent in de wet en jurisprudentie wordt begrepen, alle van buiten komende oorzaken, voorzien of niet-voorzien, waarop verkoper geen invloed kan uitoefenen, doch waardoor verkoper niet in staat is zijn verplichtingen na te komen. Werkstakingen in het bedrijf van verkoper worden daaronder begrepen;
- 14.3 Verkoper heeft ook het recht zich op overmacht te beroepen, indien de omstandigheid die (verdere) nakoming verhindert treedt nadat verkoper zijn verbintenis had moeten nakomen;
- 14.4 Partijen kunnen gedurende de periode dat de overmacht voortduurt de verplichtingen uit de overeenkomst opschorten. Indien deze periode langer duurt dan twee maanden is ieder der partijen gerechtigd de overeenkomst te ontbinden, zonder verplichting tot vergoeding van schade aan de andere partij;
- 14.5 Voor zoveel verkoper ten tijde van het intreden van overmacht inmiddels gedeeltelijk zijn verplichtingen uit de overeenkomst is nagekomen of deze zal kunnen nakomen, en aan het nagekomen respectievelijk na te komen gedeelte zelfstandige waarde toekomt, is verkoper gerechtigd om het reeds nagekomen respectievelijk na te komen gedeelte separaat te factureren. Koper is gehouden deze factuur te voldoen als ware het een afzonderlijk overeenkomst.

Artikel 15 speciale producten

- 15.1 Tenzij uitdrukkelijk anders is overeengekomen, heeft de verkoper recht bijzondere zaken, die voor koper worden gemaakt, ook voor derden te maken.
- 15.2 De koper moet monsters van bijzondere zaken keuren binnen 14 dagen na verzending. Indien verkoper na 14 dagen geen afkeurend bericht heeft ontvangen, gelden de monsters als goedgekeurd.
- 15.3 Tenzij uitdrukkelijk anders is overeengekomen zijn en blijven alle modellen, matrijzen, monsters, vormen, rekeningen en alle andere apparatuur en aanwijzingen in verband met het maken van bijzondere zaken eigendom van

- verkoper.
- 15.4 Kosten van vervanging, reparaties en onderhoud van de matrijzen komen voor rekening van de koper.
- 15.5 Tekeningen, know/how en ontwerpen die de verkoper aan koper ter beschikking heeft gesteld, mogen zonder schriftelijke toestemming niet gekopieerd of aan derden ter inzage gegeven of kenbaar gemaakt worden. Zij moeten onmiddellijk na gebruik aan de verkoper worden geretourneerd. Door enkele overtreding van deze bepaling verbeurt de koper ten behoeve van verkoper een onmiddellijke opeisbare boete van € 50.000,00 per keer en van € 5.000,00 voor iedere dag dat de overtreding voortduurt.
- 15.6 De verkoper heeft het recht matrijzen te vernietigen, ongeacht of zij eigendom zijn van verkoper of van de koper, indien die 2 jaar niet zijn gebruikt. De verkoper zal de koper 3 maanden voor afloop van de 2 jaar termijn van het voornemen tot verschromting in kennis stellen.

Artikel 16 Geschillen

De rechter in de vestigingsplaats van verkoper is bij uitsluiting bevoegd van geschillen kennis te nemen. Niettemin heeft verkoper het recht het geschil voor te leggen aan de volgens de wet bevoegde rechter.

Artikel 17 Toepasselijk recht

Op elke overeenkomst tussen verkoper en koper is Nederlands recht van toepassing. Het Weens Koopverdrag is uitdrukkelijk uitgesloten.

Artikel 18 Deponering voorwaarden

Deze voorwaarden zijn zowel in Nederlands als in het Engels gedeponereerd ten kantore van Kamer Gooi-, Eem- en Flevoland onder nummer 08057144

🇬🇧 TERMS AND CONDITIONS OF DG RUBBER HOLLAND B.V., NIJKERK

Artikel 1 Interpretation

Supplier: DG Rubber Holland BV, the user of the terms and conditions;

Customer: the other Party of the Supplier, the buyer, the Client;

Agreement: the contract between Supplier and Customer;

2. General

- 2.1 These terms and conditions shall govern all social offers and agreements between supplier and customer on which Supplier declare these terms and conditions as applicable, unless both parties expressly and in writing have agreed otherwise;
- 2.2 These terms and conditions also apply to all agreements with the Customer when the supplier is making use of the third parties for the implementation of the agreement;
- 2.3 The terms and conditions the Customer are expressly not applicable, unless both parties agree otherwise in writing. If terms and conditions of both parties are applicable the provisions of the terms and conditions of the Supplier prevail in the event these are in conflict;
- 2.4 Provided that one or several of the provisions of these terms and conditions are ineffective or unrealizable, the effectiveness or unrealizable provisions by effective provisions, which correspond to the intended objective or unrealizable provisions.

3. Special offers/Offers/Prices

- 3.1 All special offers in any form are non-binding, unless a term of acceptance has been mentioned in the special offer;
- 3.2 The offers made by the Supplier are informal unless otherwise indicated. Supplier is only bound by the offer made if the Customer has accepted the offer within 14 days in writing and the materials offered are still available and/or deliverable;
- 3.3 If a natural person enters into an Agreement for another natural person he declares - by signing the Agreement - that he is fully authorized. This person is jointly liable together with the other natural person for all obligations arising from this Agreement;
- 3.4 If the acceptance is different from the contents of the offer, Supplier is not bound by it. The Agreement will not be made corresponding to this different acceptance, unless Supplier states otherwise;
- 3.5 Suppliers is not bound to deliver a part of the goods mentioned in a special offer against the given price when it is part of a combined offer;

- 3.6 Special offers or offers do not apply to re-orders;
- 3.7 The delivery dates given in any Agreement are estimates only and by any delay Customer shall not be entitled to dissolve the Agreement or to any compensation, unless expressly agreed otherwise;
- 3.8 Agreements to which Supplier is a party shall only be deemed concluded when Supplier has accepted the order in writing and/or in case of delivery the ordered goods ex warehouse by Supplier to Customer;
- 3.9 All amounts stated in the special offers/offers apply to deliver ex warehouse, are in Euros and include costs of loading, are exclusive VAT, government taxes, delivery charges, freight costs and administration costs, unless expressly agreed otherwise;
- 3.10 Supplier may pass on price increases of more than 10% if between moment of offering/accepting and delivery price changes have occurred due to e.g. foreign exchange fluctuations, wages, raw materials, semi-finished products or packaging material;
- 3.11 If Supplier and Customer enter into more than one Agreement these terms and conditions apply regardless if these expressly agreed or not.

4. Delivery

- 4.1 Delivery of the goods will be ex warehouse of Supplier, unless both parties agreed otherwise;
- 4.2 Customer has to take delivery of the goods at the moment Supplier deliver the goods or has them delivered or at the moment as agreed in the Agreement;
- 4.3 If Customer rejects the goods or is negligent in giving information or instructions regarding delivery, Supplier shall be entitled to store the goods for the account and at risk of Customer; In case of cash-on-delivery Supplier will always charge the cash-on-delivery costs to Customer;
- 4.4 In case of delivery Supplier is entitled to charge possible costs for delivery, Free delivery for orders above €450,- (four hundred and fifty euros) exclusive of VAT. In case of export Customer shall pay for the freight costs;
- 4.5 The freight costs are determined by weight and will be charged separately;
- 4.6 Any dates quoted for delivery are approximate only, and the time of delivery is not of the essence. If Supplier exceeds the time limit Customer shall send a letter off formal notice;
- 4.7 If Supplier needs information of Customer for carrying out the Agreement, delivery time will commence on receipt of this information;
- 4.8 Supplier reserves the right to effect a delivery

in parts. Supplier shall be entitled to charge for partial delivery.

5. Examinations and claims

- 5.1 Customer has to examine the goods and their packaging immediately on delivery or as quickly as possible. In addition, he has to convince himself of the Agreement-appropriate quality and quantity of the delivered good;
- 5.2 A sample shown to Customer is to be considered as indicative and will not exactly match the goods to be delivered, unless expressly agreed that it would be so;
- 5.3 Possible visible defects shall be reported in writing within 8 days after delivery to Supplier; Supplier is given a reasonable opportunity of examining the defects;
- 5.4 If under the previous paragraph complaints are made in time Customer is still required to accepting and paying the purchased goods. If Customer wants to return defective goods he shall do so with prior written permission of Supplier and will be returned in way Supplier indicates.

6. Terms of payment

- 6.1 In the case of payment for orders under €100,0 (one hundred euros) this shall be done cash-on-delivery. Other payments shall be done in euros within 30 days of the date of invoice in a way indicated by Supplier. Payment of orders above €5.000,- (five thousand euros) shall be done as follows:
- 1/3 on receipt of the order;
- 1/3 when goods are ready to be sent at Suppliers;
- 1/3 within a month of paying the second instalment payment;
- 6.2 Objections to the amount of the invoice do not suspend the payment obligation;
- 6.3 If Customer fails to make a payment within the terms of payment of 30 days, Customer is legally in default. Customer must then pay interest of 1% per month or part of that month unless the legal interest and/or commercial interest is higher, in which case the highest interest applies. The interest to be paid on the amount payable will be calculated from the date that Customer is legally in default until the date of payment of the full amount;
- 6.4 In case of liquidation, (application of) bankruptcy, admission to debt restructuring under the Natural Persons Dept Rescheduling Act, sequestration or (provisional) suspension of payments of Customer the claims of Supplier become payable on demand immediately.

- 6.5 Payments firstly reduce the costs, then the interests owed and finally the principal sum and accrued interest.
- 6.6 Customer's right to offset his claims on Supplier is excluded

7. Debt collection fees

- 7.1 If Customer defaults in (timely) payment all reasonable costs incurred in obtaining payment out of Court will be at the expense of Customer. The collection costs are calculated in accordance with the rates for collection issues as advised by the Dutch Bar Association;
- 7.2 If user had to incur costs that were reasonably necessary these are also eligible for reimbursement;
- 7.3 Possible reasonable legal expenses and execution costs are also at the expense of Customer;

8. Reservation of Title

- 8.1 All goods delivered by Supplier shall remain Suppliers property until all obligations regarding all Agreements entered into with Supplier are met by the Customer;
- 8.2 The Customer may not pledge the goods that are subject so reservation of title nor encumbered them in any other manner;
- 8.3 In the event that a third parties levy attachment on good supplied subject to the reservation of title or wish to create or assert rights on them, Customer is required to inform Supplier of this as soon as possible;
- 8.4 Items delivered by Supplier which, pursuant to section 1 of this article, are subject to reservation title, may only be resold within the scope of normal business operations and may never be used as means of payment;
- 8.5 In the event that Supplier wishes to exercise its property rights referred to this article, Customer hereby unconditionally and irrevocably authorises Supplier or third parties to be designated by Supplier to access those locations where the Supplier's goods are located and to retrieve those goods.

9. Guarantee rights

- 9.1 The goods supplied by Supplier will be in accordance with the technical requirements and specifications set by Dutch Law;
- 9.2 The Guarantee referred to in section 1 of this article shall be valid for a period of 6 months following delivery;
- 9.3 This guarantee is limited to:
- Manufacturing faults and does therefore not covered damage resulting from ware and improper and/or in expert use;
 - Delivery to buyers in the Netherlands;
- 9.4 This Guarantee will expire:
- in case of resale of the goods delivered, unless parties expressly agreed otherwise
 - in case of inappropriate or improper use by Customer or third party
 - in case of modifications, changes or repairs of the goods delivered by Customer or third party;
- 9.5 As long as the Customer fails to perform its obligations arising from the agreements concluded between the parties, it cannot invoke this warranty provision/

10. Suspension and termination

- 10.1 Supplier is authorized to suspend compliance with its obligations or dissolve the Agreement if:
- Customer fails to comply in full or good time with obligations arising from the Agreement;
 - circumstances come to the knowledge of Supplier after the Agreement is concluded which constitute a serious reason to fear that Customer will not comply in full or good time with its obligations. If there is ground to fear that the purchase will only partially be fulfilled or not properly, the suspension is only permissible to the extent that the shortcoming justifies the same;
 - Customer upon entering into the Agreement was requested to provide security for

compliance with the obligations arising from the agreement and that security is provided, the competence expires to postponement unless payment is unreasonably delayed;

- 10.2 Moreover Supplier is authorized to dissolve the Agreement or cause it to be dissolved if circumstance arise such that compliance with the Agreement may no longer be demanded of it, or may not be demanded according to any measure of reasonableness and fairness, or if circumstances otherwise arise so that the unaltered continuation of the Agreement may no longer be reasonably expected of it;
- 10.3 If the Agreement is dissolved, all amounts receivable by Supplier will be immediately due and payable. If Suppliers suspends performance of its obligations, it will retain its claim ensuing from the law and the Agreement;
- 10.4 Supplier always reserves the right to claim compensation.

11. Order cancellation

- 11.1 In the event that a Customer wishes to cancel a contract once it has been entered into, cancellation charge of 10% of the order price agreed upon (including VAT) will be made, without prejudice to Suppliers right to compensation in full for loss, including loss of profits;
- 11.2 If, in the event of cancellation, Customer refuses to purchase goods, such as materials and raw materials already acquired by Supplier, irrespective of whether these goods have been treated or processed, Customer will be obligated to pay the Supplier all ensuing costs;

12. Liability

- 12.1 Should the goods delivered by Supplier be defective, Suppliers liability towards Customer is limited to what is defined under Guarantee rights of these terms of conditions;
- 12.2 Should Supplier be liable for direct damage, this liability will be limited to the amount is paid by its insurer, or at least up to the invoice amount, or to the amount corresponding with that part of the Agreement to which the liability pertains;
- 12.3 Supplier shall never be liable for indirect damage including consequential damage, loss of profit, loss of savings and damage due to stagnation of business;
- 12.4 The limits of liability for direct damage included in these terms and conditions shall not apply if the damage is due to intent or gross negligence of Supplier or his subordinates.

13. Transfer of risk

- 13.1 The risk of loss or damage to the goods that are subject of the Agreement will pass to Customer at the time the goods in question are legally and/or actually delivered to Customer and have thus come under Customer's control or that third party designated by Customer;
- 13.2 If customer arranges transport, the expense and risk incurred will be solely for Customer

14. Force Majeure

- 14.1 Neither party will be obligated to fulfil any obligation if it is prevented from doing so due to a circumstance which cannot be attributed gross negligence or an intentional act or omission on its part, and which is also not for its account pursuant to the law, a juristic act or generally prevailing opinion;
- 14.2 In these terms and conditions, force majeure shall include, in addition to its definition provided by law and case law, all external foreseeable or unforeseeable causes which the supplier cannot influence but as result of which Supplier is unable to fulfil its obligations. Strikes at Supplier's company are included;
- 14.3 Supplier is also entitled to refer to force majeure, should the circumstances arise which makes a (further) execution of its duties impossible, after Supplier should already have executed them;
- 14.4 Parties may suspend the obligations ensuring from the Agreement during the period that the

- force majeure continues. If this period lasts longer than two months, then each party is entitled to terminate the Agreement without any obligation to pay damages to the other party;
- 14.5 To the extent that, at the time force majeure takes effect, Supplier has partially complied with its obligations under the Agreement or will be able to comply with them, and independent value is attached to that part of the obligations that has been or will be complied with, Supplier is entitled to invoice separately for the said part. Customer shall be had to pay this invoice as if it were as separate agreement;

15. Special product

- 15.1 Unless expressly agreed otherwise, Supplier is entitled to make special product made for Customer, also third parties;
- 15.2 Customer is required to inspect samples of special products within 14 days after delivery. If Supplier doesn't receive a message of disapproval within 14 days the samples shall be considered as approved;
- 15.3 Unless expressly agreed otherwise, all models, matrices, samples, moulds, drawings and all other equipment and instructions regarding the manufacturing of these special products are and shall remain property of Supplier;
- 15.4 Costs of replacements, repairs and maintenance of the matrices are at the expense of Customer;
- 15.5 Drawings, know how and designs made available by Supplier to Customer may not be copied, or made available for examinations to third parties without written consent. The shall immediately after use be returned to Supplier. If Customer infringes upon this regulation he forfeits immediately payable fine of EUR 50.000,- (fifty thousand euros) per occasion that the violation takes place and EUR 5.000,- (five thousand euros) per day that the violation continues;
- 15.6 Supplier has the right to destroy matrices, irrespective of their ownership, if they haven't be used for 2 years. Supplier will inform Customer of his intention to destroy them 3 months in advance before the end of 2 year period.

16. Disputes

In the absence of mandatory rules of law to the contrary, the court in Supplier's place of establishment has exclusive competent jurisdiction. Nevertheless Supplier will be entitled to submit any disputes to the competent court according to the law;

17. Governing Law

Dutch Law shall apply to all Agreements between Supplier and Customer. The Vienna Sales Convention is expressly excluded.

18. Registration

These Terms and Conditions are registered in Dutch with the Chamber of Commerce Gooi-, Eem-, en Flevoland under number 08057144





**BEZOEKADRES**

Melkrijder 14
3861 SG Nijkerk
The Netherlands

POSTADRES

Postbus 1031
3860 BA Nijkerk
The Netherlands

TELEFOON

+ 31 (0)33 245 78 86

INTERNET

www.dgrubberholland.nl

E-MAIL

info@dgrubberholland.nl